

Preliminaries and final

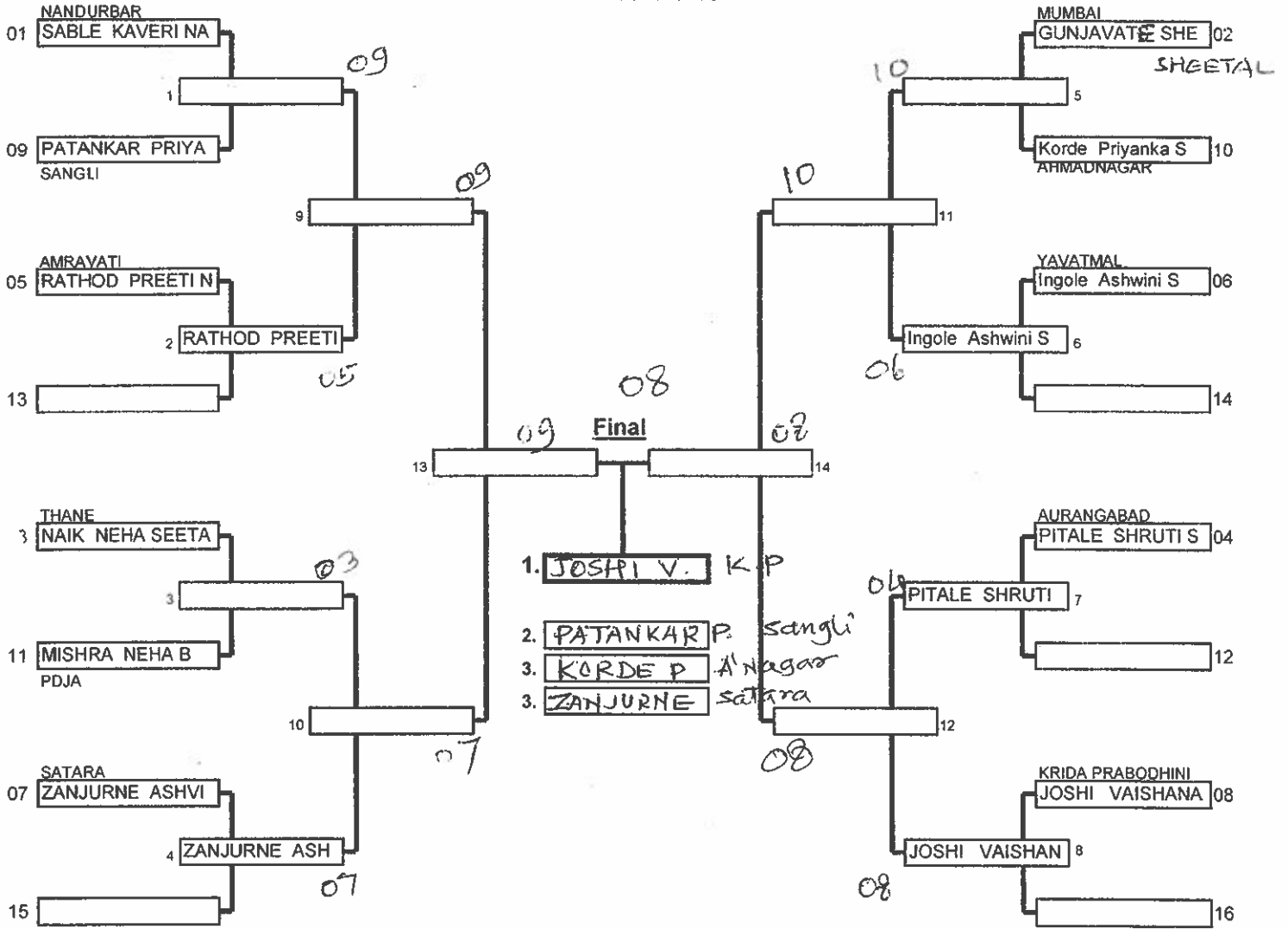

Repechage

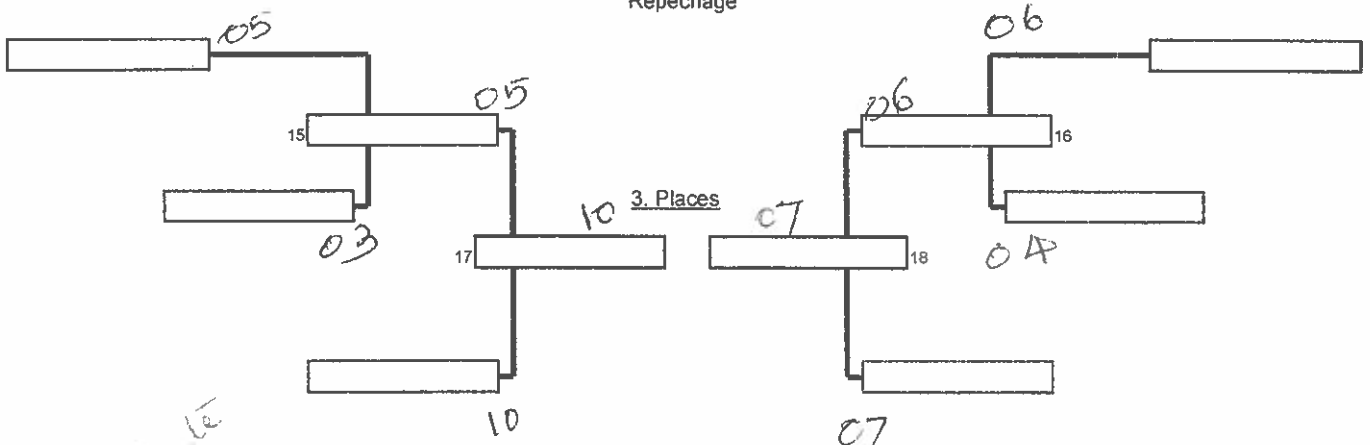

*certificates
Result
OK
enlun*

Preliminaries and final

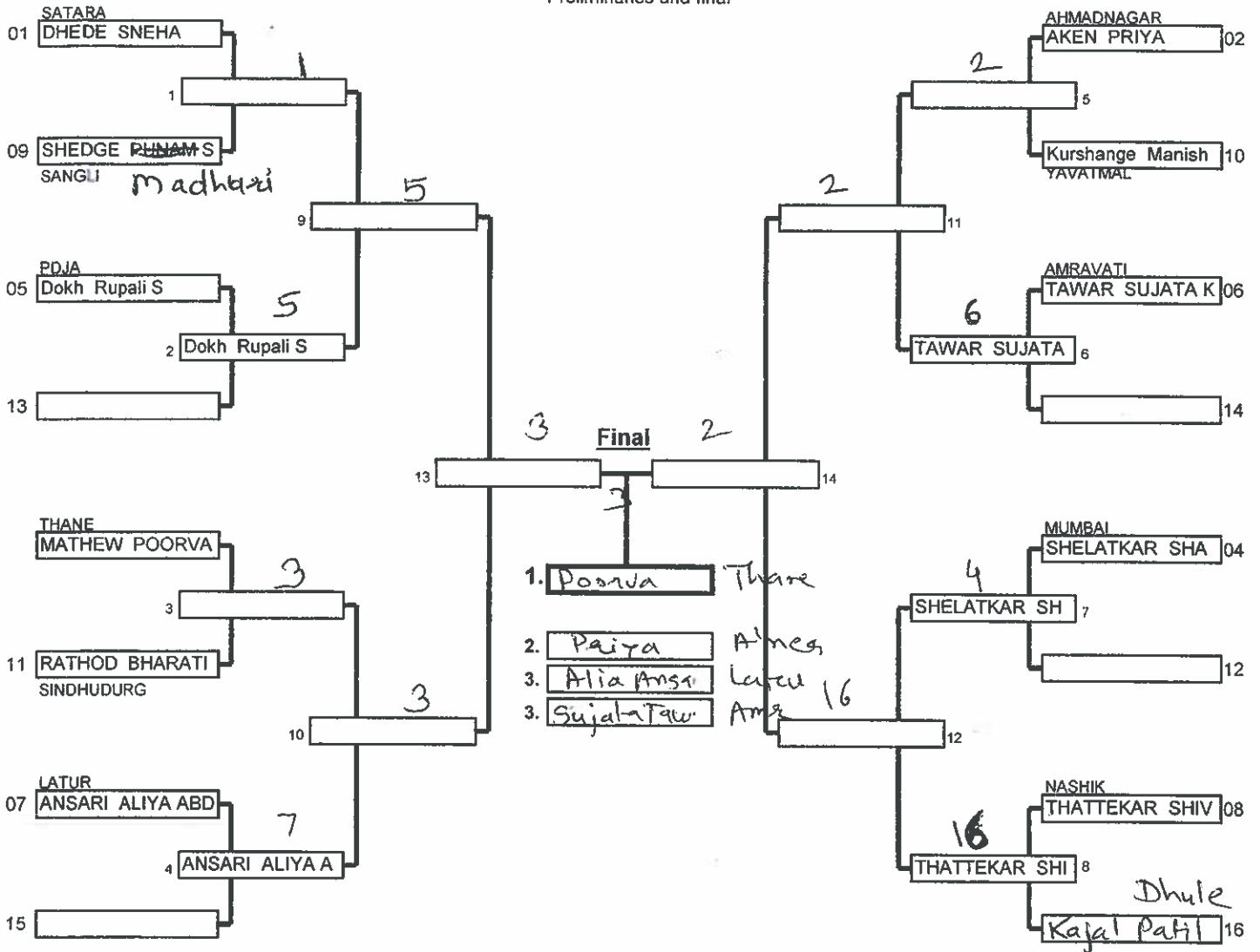

Repechage

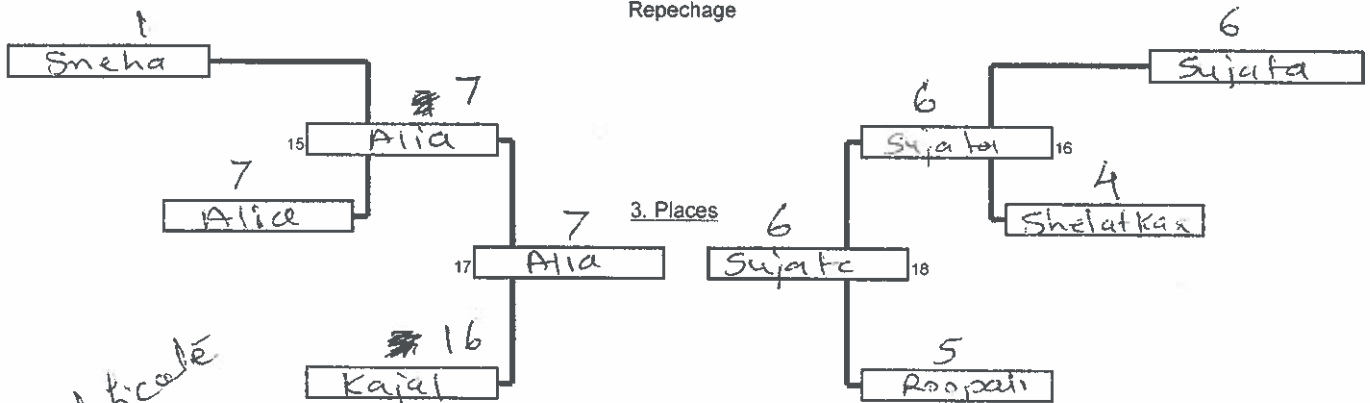

certificate of result OK

Preliminaries and final

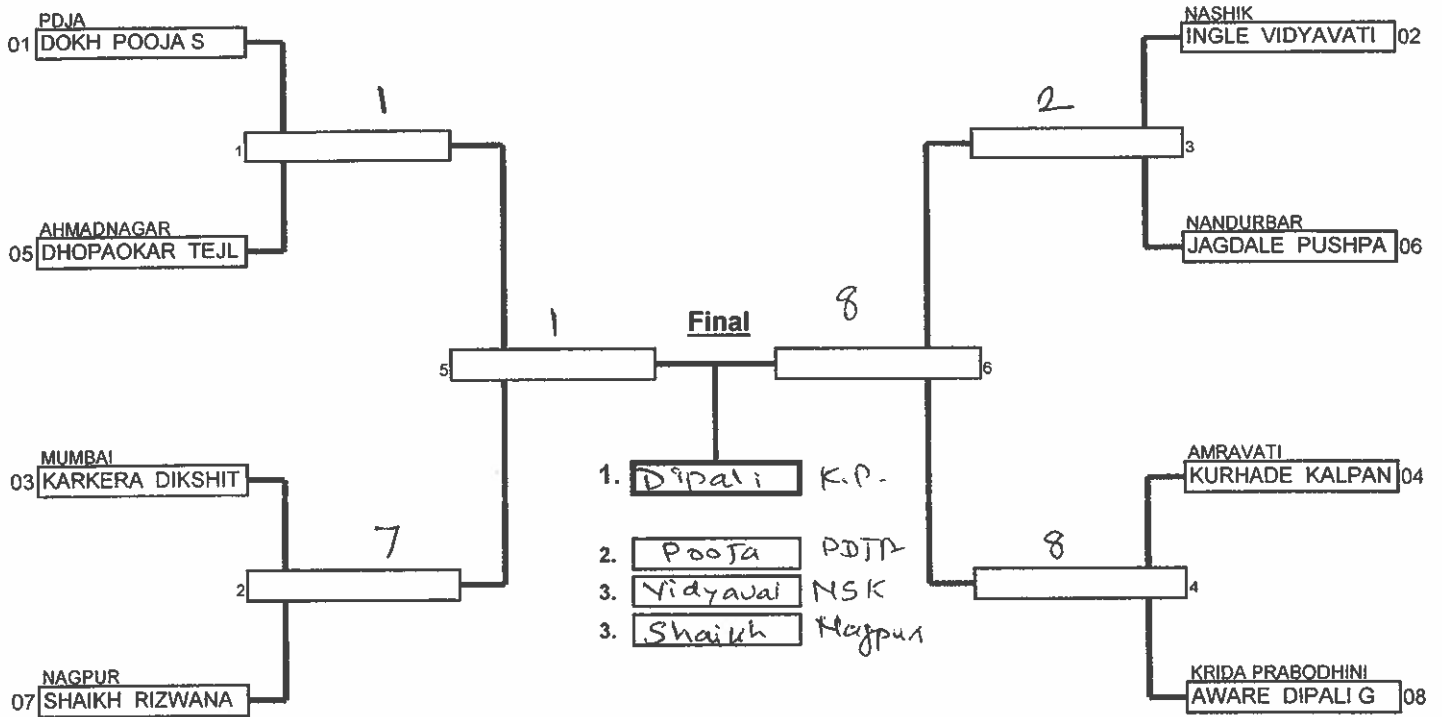

Repechage

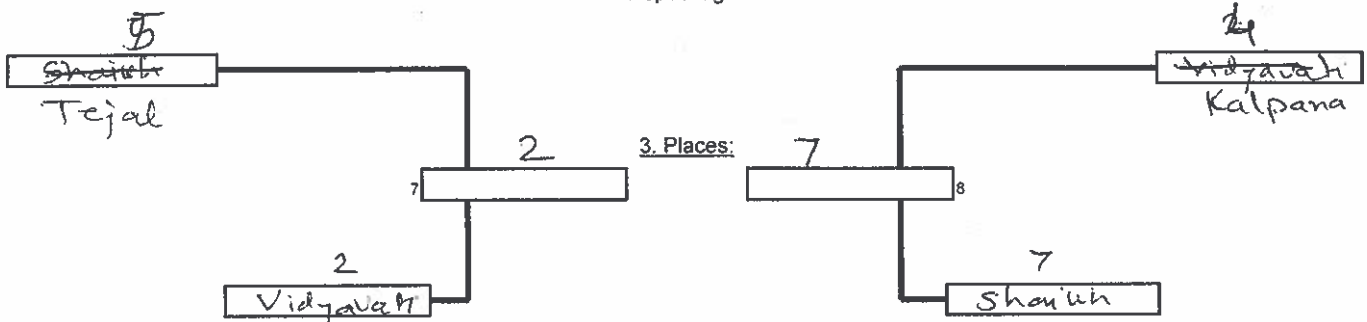

select
7
centrale
OK
alain

Preliminaries and final

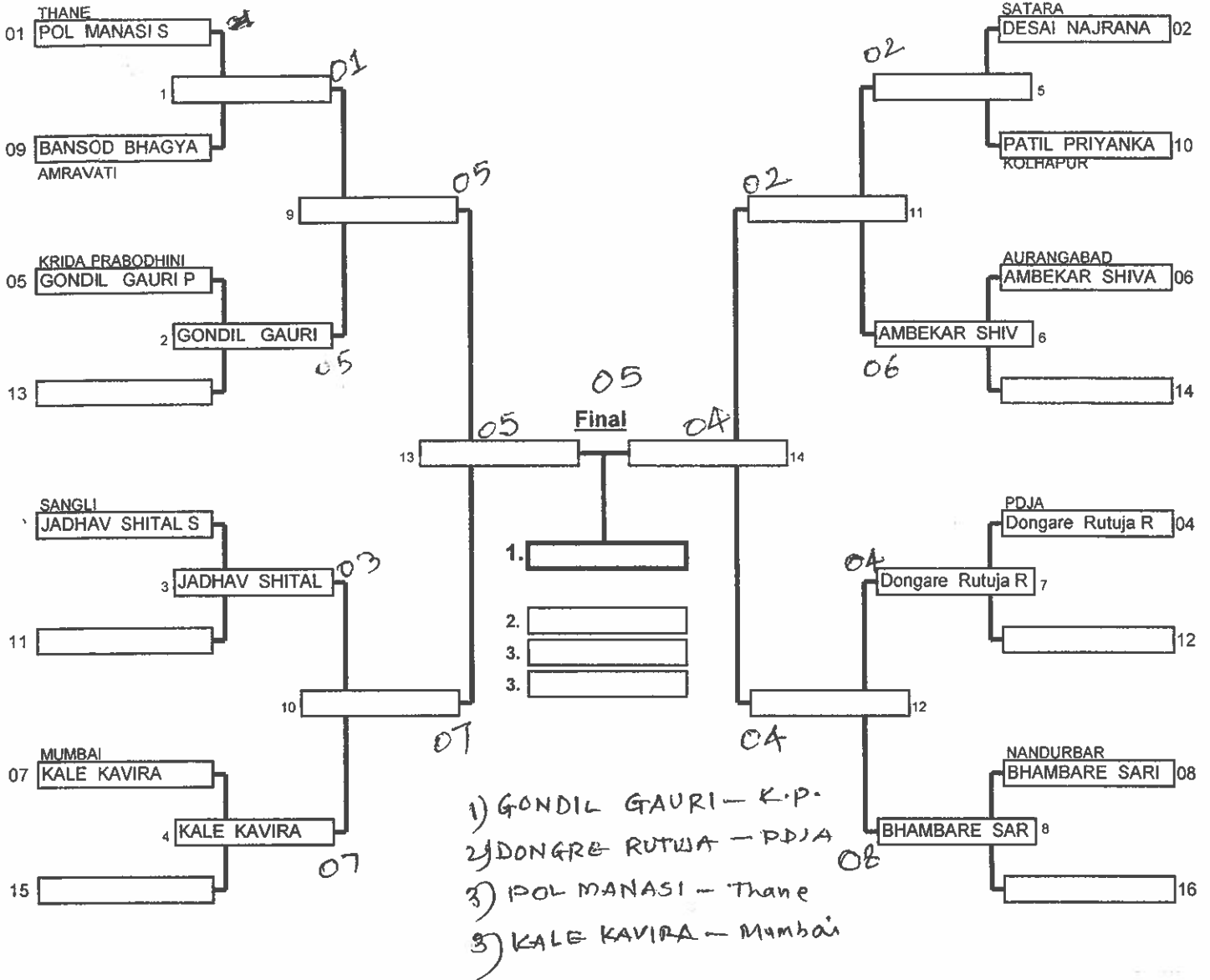

Repechage

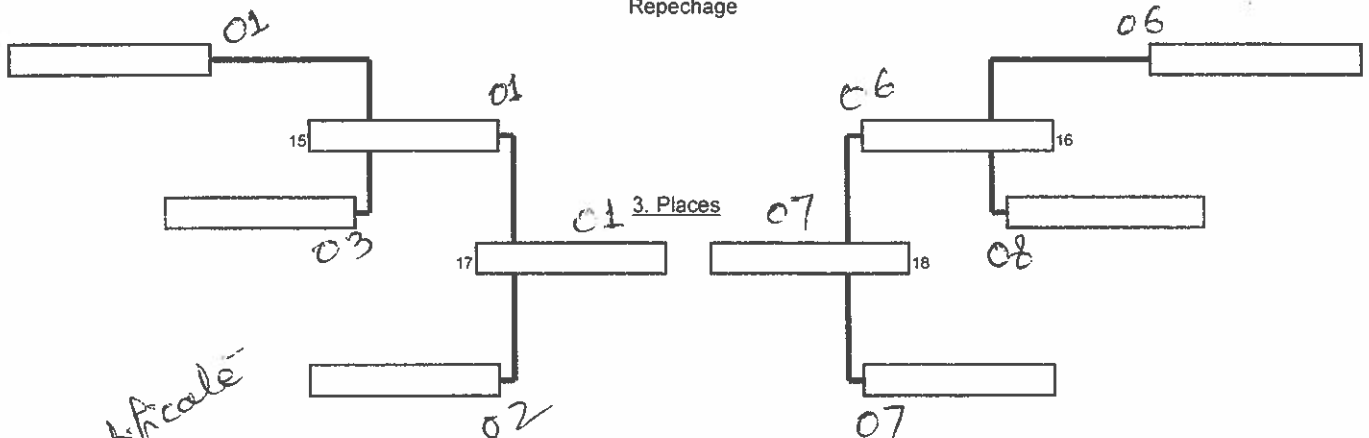

Certificate
 &
 Result
 OK *dhin*



Preliminaries and final

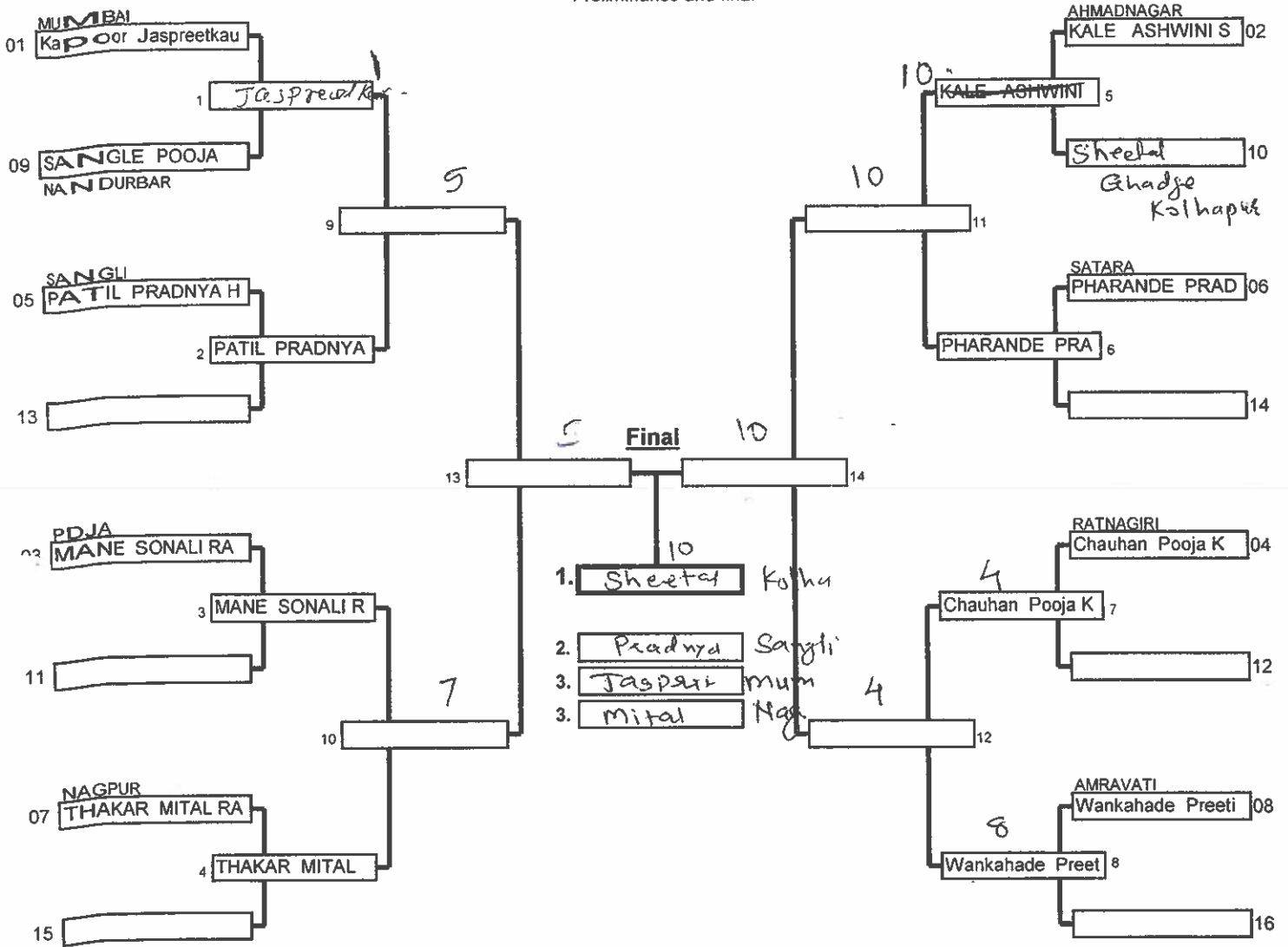

Repechage

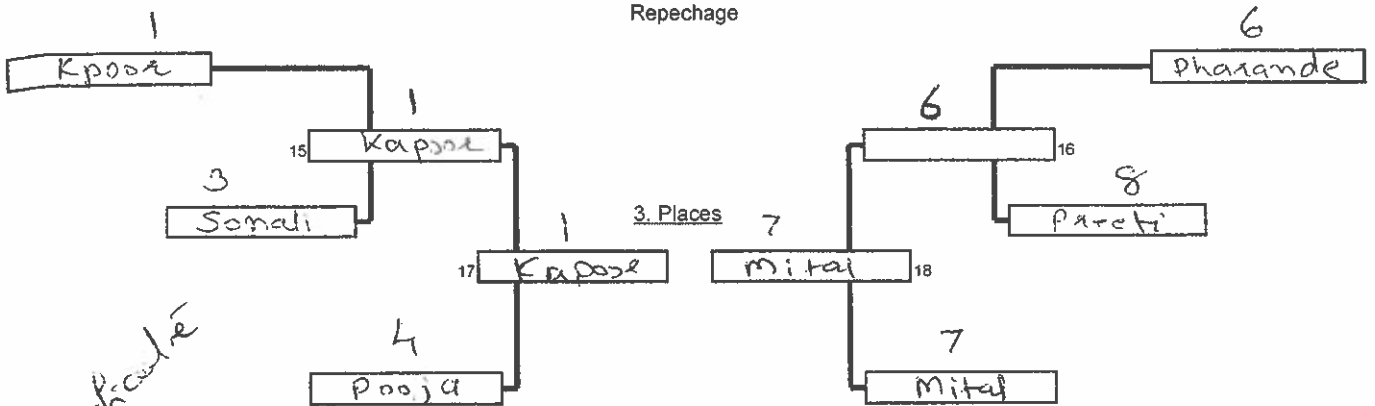

Certificate & Result OK
Awin

Poolk.

Nr. Name	Club	01	02	03	04	Wins / Pts	Weight	Place
01 ZENDE VAISHANAVI NITIN	KOLHAPUR		0	0	0	0 0	kg	
02 DHOPESHWAR POOJA	PDJA	0		0	0	0 0	kg	
03 DEOLE INDRAYANI	MUMBAI	0	0		0	0 0	kg	
04 CHAVAN PRATIKSHA BAPURA	AMRAVATI	0	0	0		0 0	kg	

Matches:

Round/Comp	Name ("blue")	Name ("white")	Winner	Time	Score	Result
1	01-02 ZENDE VAISHANA	DHOPESHWAR PO	Vaishnavi	3:28	Ippon	1.
	03-04 DEOLE INDRAYANI	CHAVAN PRATIKS	Indrayani	3:22	Ippon	2.
2	03-01 DEOLE INDRAYANI	ZENDE VAISHANA	Vaishnavi	3:28	Ippon	3.
	04-02 CHAVAN PRATIKS	DHOPESHWAR PO	Pratiksha	3:58	Wazari - A - Ippon	
3	01-04 ZENDE VAISHANA	CHAVAN PRATIKS	Vaishnavi	2:58	Wazari - A - Ippon	
	02-03 DHOPESHWAR PO	DEOLE INDRAYANI	Pooja	2:20	Ippon	

- 1) Vaishnavi Zende - Kolhapur
- 2) Indrayani Deole - Mumbai - 180
- 3) Pooja Dhopeswar - PDJA 181

Situ Indrayani - 38 sec.
 Pratiksha - 52 X
 Bama Pooja - 1.40 sec.

Poolk.

Nr. Name	Club	01	02	03	Wins / Pts	Weight	Place
01 PHATARPEKAR POOJA	MUMBAI		0	0	0 0	kg	
02 MANWARE PRIYA SUDHAKAR	NAGPUR	0		0	0 0	kg	
03 HOLE SHWETA	RAIGAD	0	0		0 0	kg	

Matches:

Round/Comp	Name ("blue")	Name ("white")	Winner	Pts.	Scores
1 01-02	PHATARPEKAR PO	MANWARE PRIYA	Phatarpekar	1	Osai kon Ippon
2 02-03	MANWARE PRIYA	HOLE SHWETA	manware	1	Osai kon Ippon
3 03-01	HOLE SHWETA	PHATARPEKAR PO	phatarpekar	1	Ippon

1. Phatarpekar
2. manware Priya
3. Hole Shweta

✓ certificate
+
result
OK
↓
admits

Mumbai first
but Nagpur girl defeated Raigad girl
so no need of selection

for National

Priya sudhakar manware (Nagpur)

Poolk.

Nr. Name	Club	01	02	03	04	Wins / Pts	Weight	Place
01 INAMDAR NILOFAR	MUMBAI		0	0	0	0 0	kg	
02 SHAIKH ZEBGA GAFFAR	AHMADNAGAR	0		0	0	0 0	kg	
03 NIKAM ANITA	PDJA	0	0		0	0 0	kg	
04 Tembhurne Pramila Sahdev	AMRAVATI	0	0	0		0 0	kg	

Matches:

Round/Comp	Name ("blue")	Name ("white")	Winner	Pts.	Scores	
1	01-02 INAMDAR NILOFAR	SHAIKH ZEBGA GAF	Shaik Zeba	1	1 PPN	1.
	03-04 NIKAM ANITA	Tembhurne Pramila	Nikam Anita	1	wazaari 2	2.
2	03-01 NIKAM ANITA	INAMDAR NILOFAR	Nikam Anita	1	walkover	3.
	04-02 Tembhurne Pramila	SHAIKH ZEBGA GAF	Tembhurne	1	1 PPN	
3	01-04 INAMDAR NILOFAR	Tembhurne Pramila	Tembhurne	1	1 PPN	
	02-03 SHAIKH ZEBGA GAF	NIKAM ANITA	Nikam Anita	1	1 PPN	

111 1) Nikam Anita - PDJA

027 2) Tembhurne Pramila - Amravati

112 3) Shaik Zeba - A'Nagar

certificate
result

OK
Aur

Sr Men

Beloe 56 Kg

42nd SENIOR STATE JU NATIONAL SELECTION

AURANGABAD

12/13/2014

20 Cmp

Elimination System with Single Repechage for 17 to 32 Competitors

5 min

Matte

Preliminaries and final

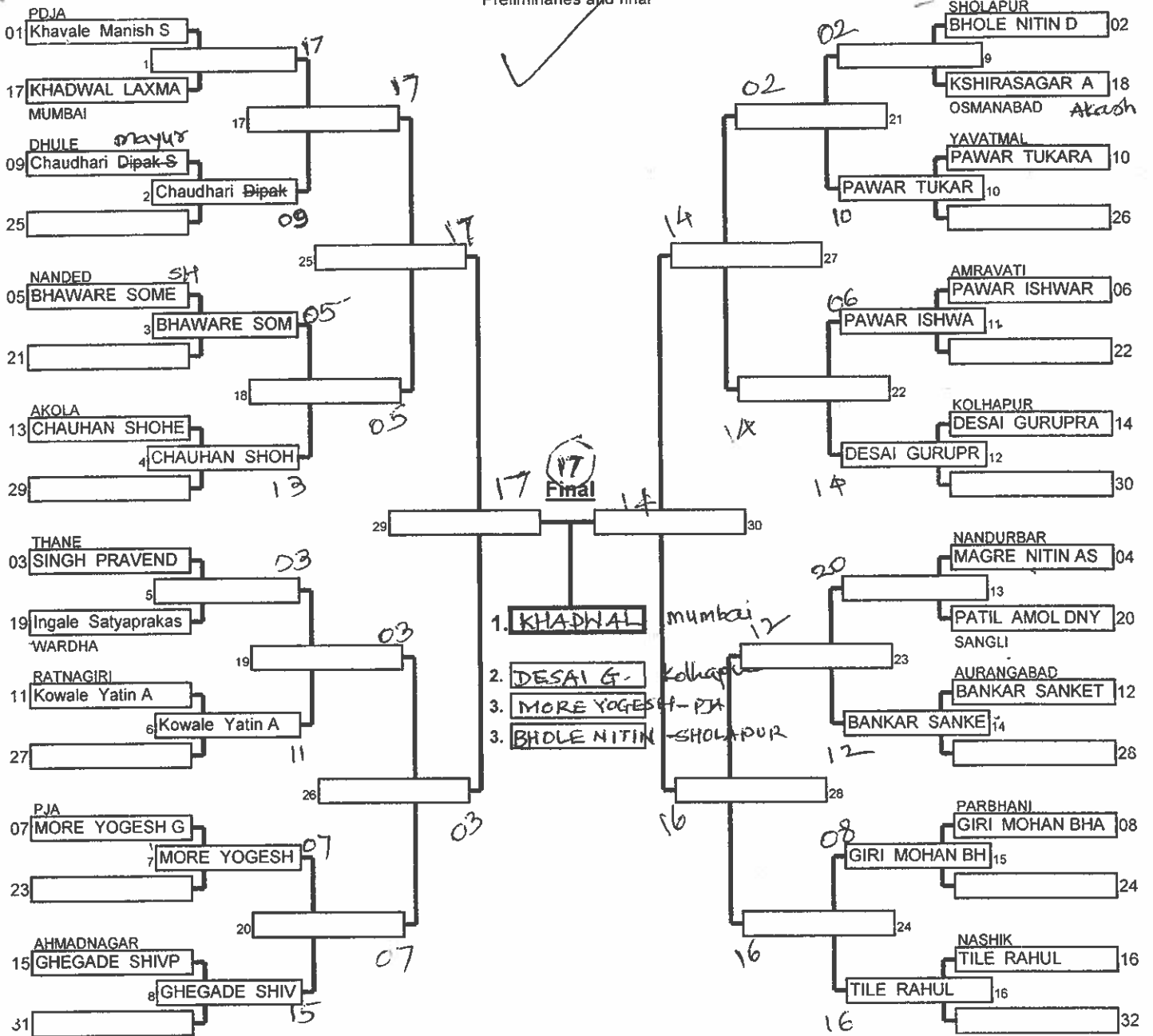

Repechage

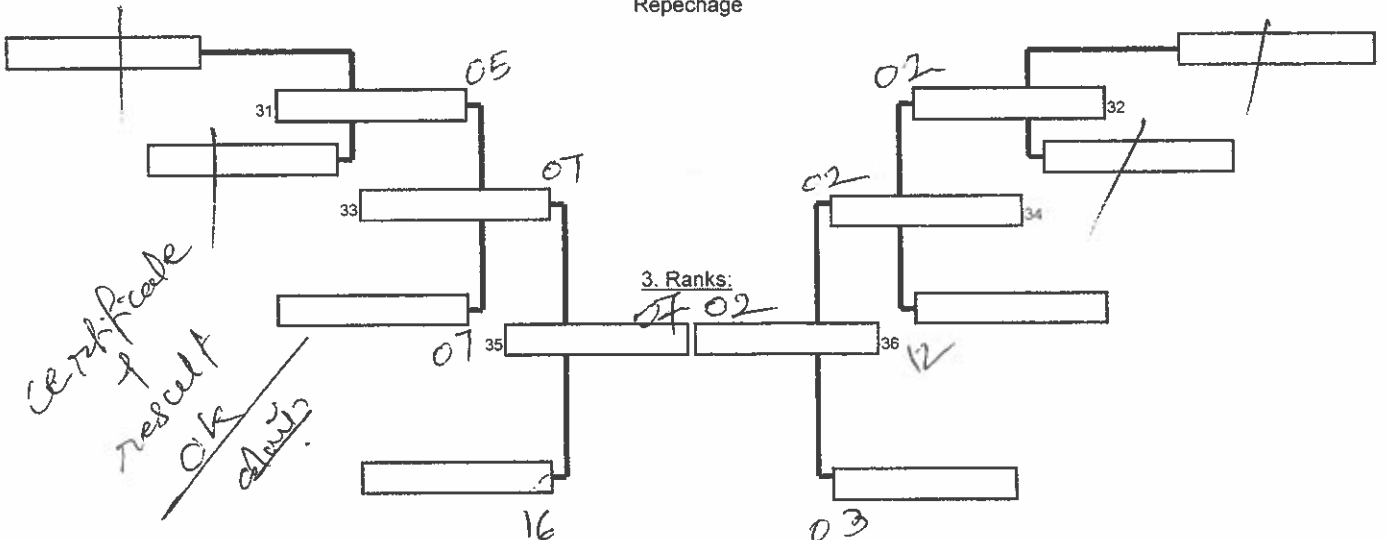

Sr Men

Below 60 Kg

42nd SENIOR STATE JUDO NATIONAL SELECTION

AURANGABAD

12/13/2014

21 Cmp.

Elimination System with Single Repechage for 17 to 32 Competitors

5 min

Matte

Preliminaries and final

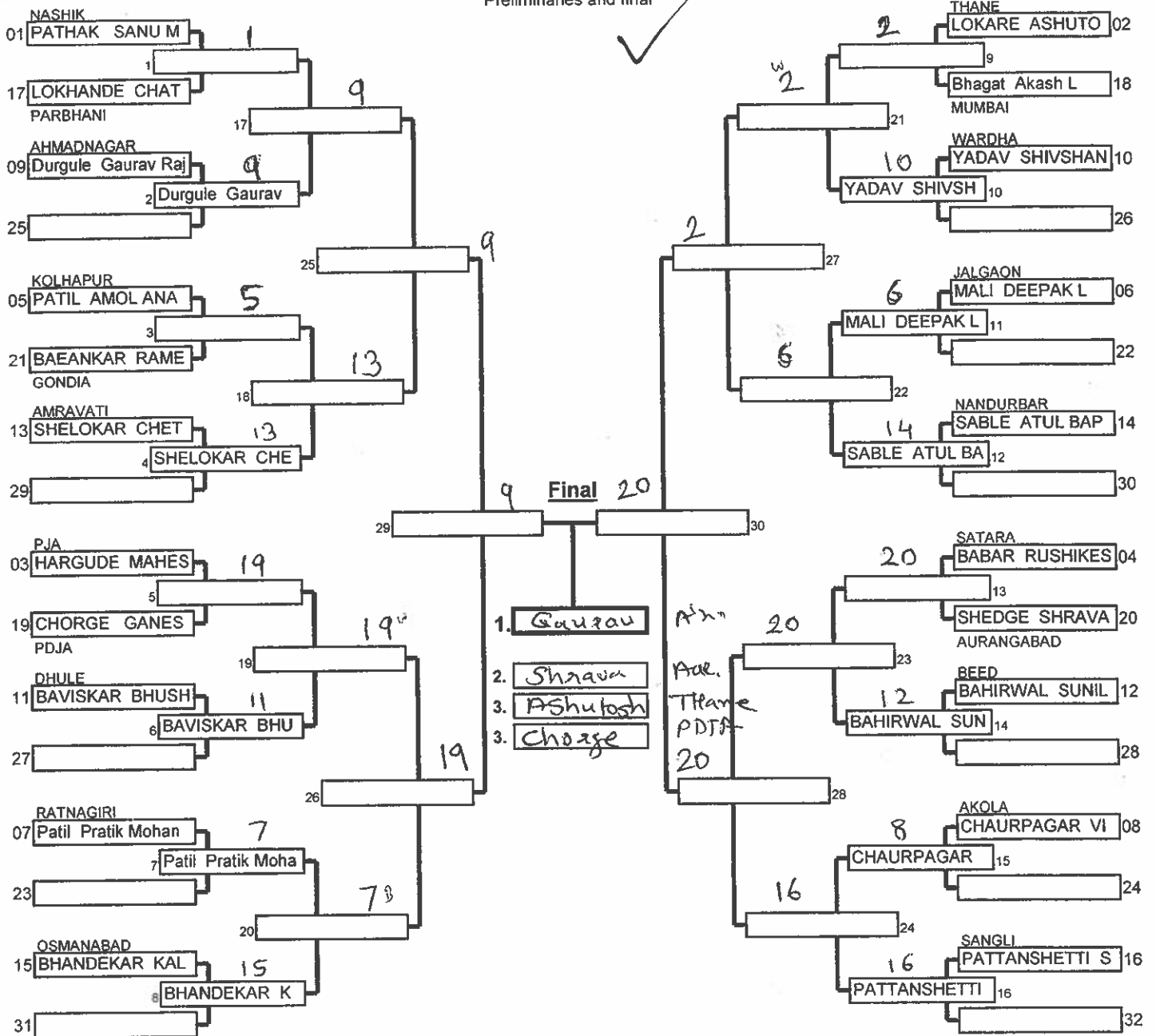

Repechage

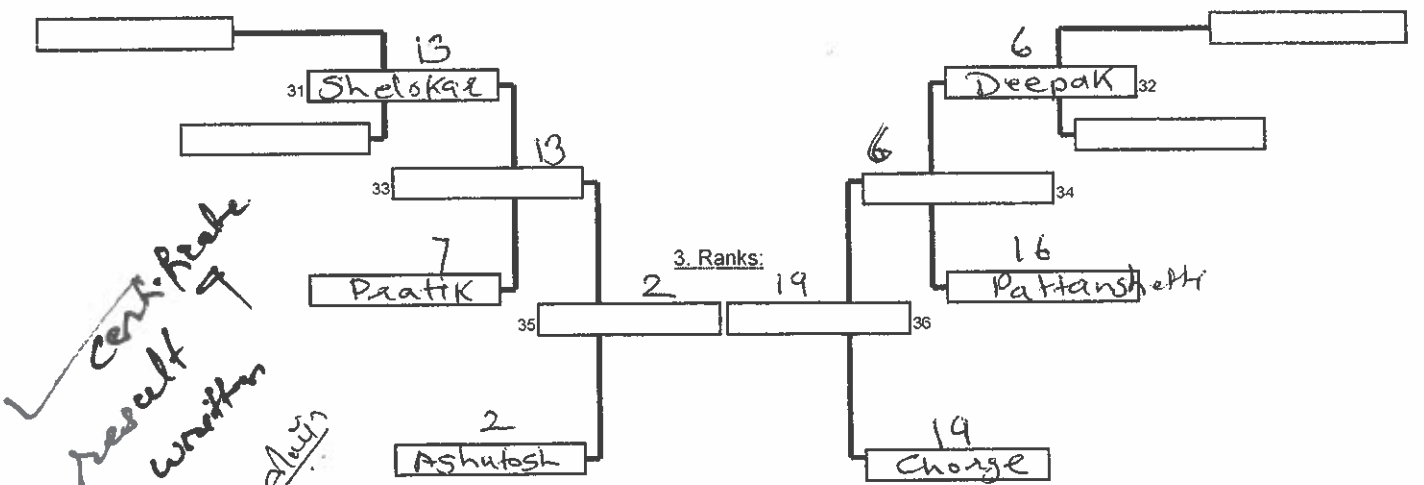

*cert. made
result
written
dawn*

Preliminaries and final

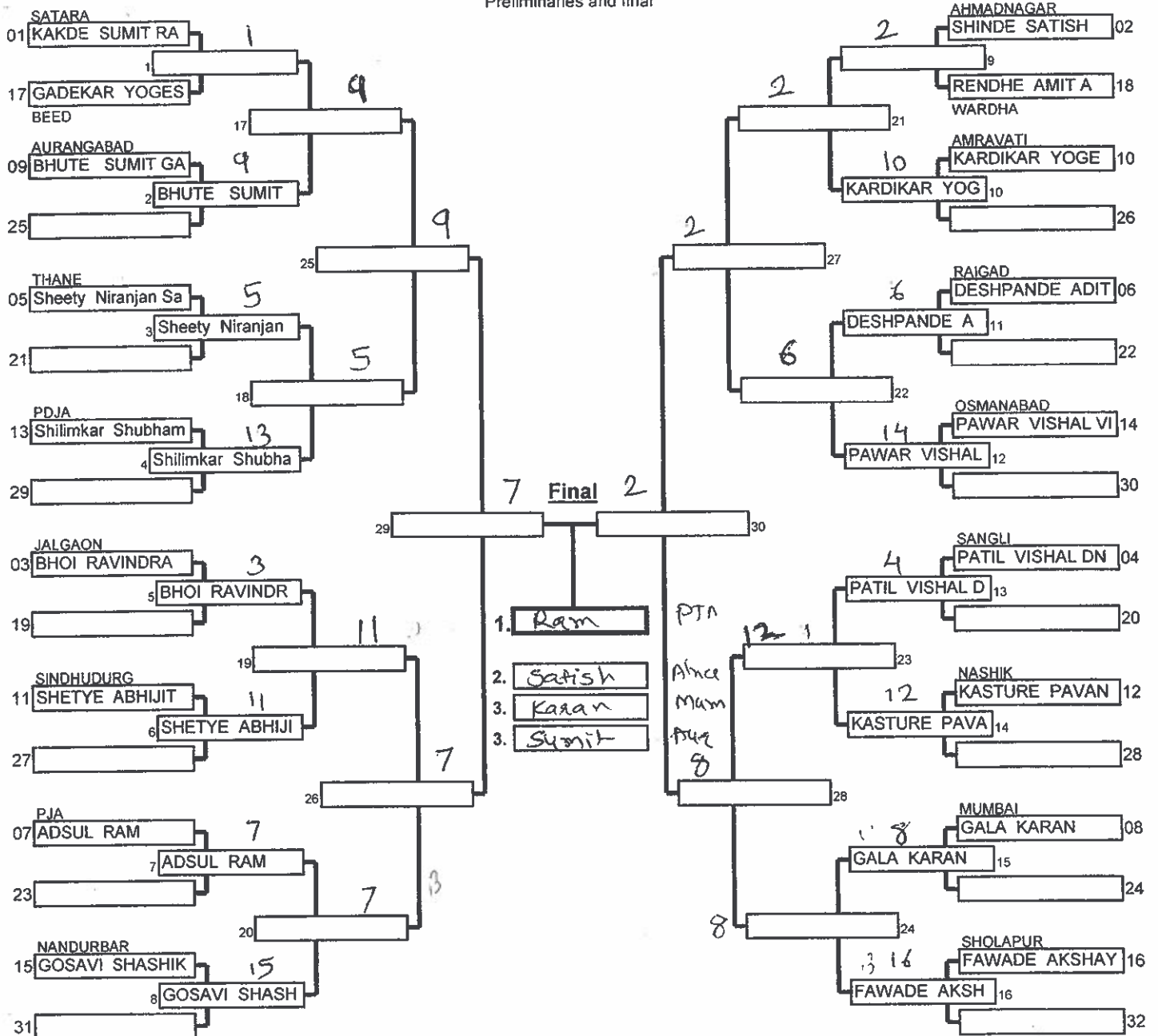

Repechage

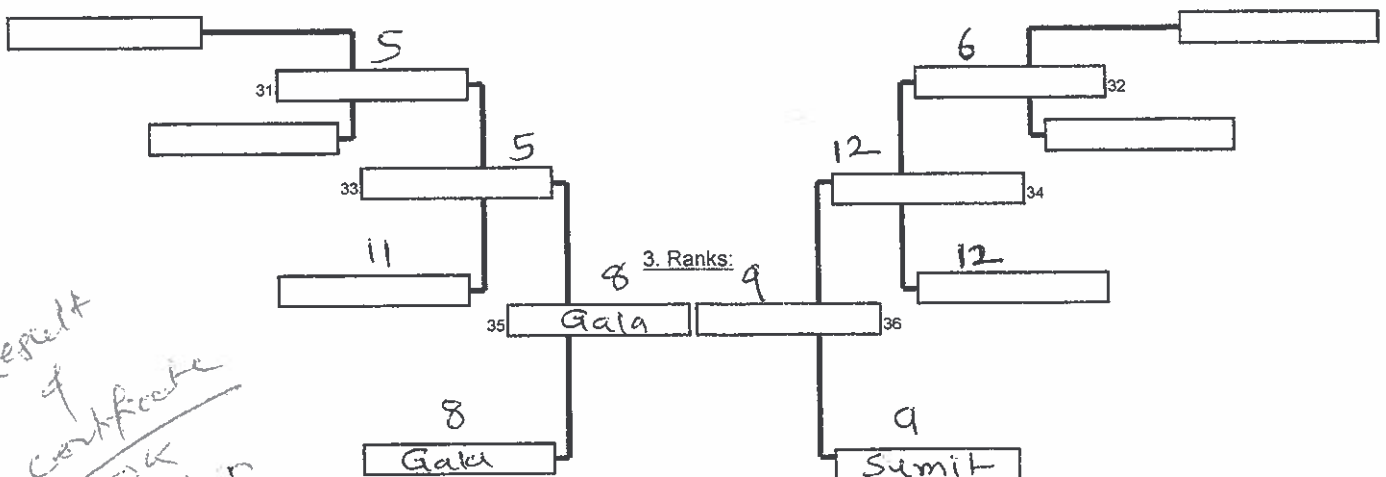

Result of certificate OK

Preliminaries and final

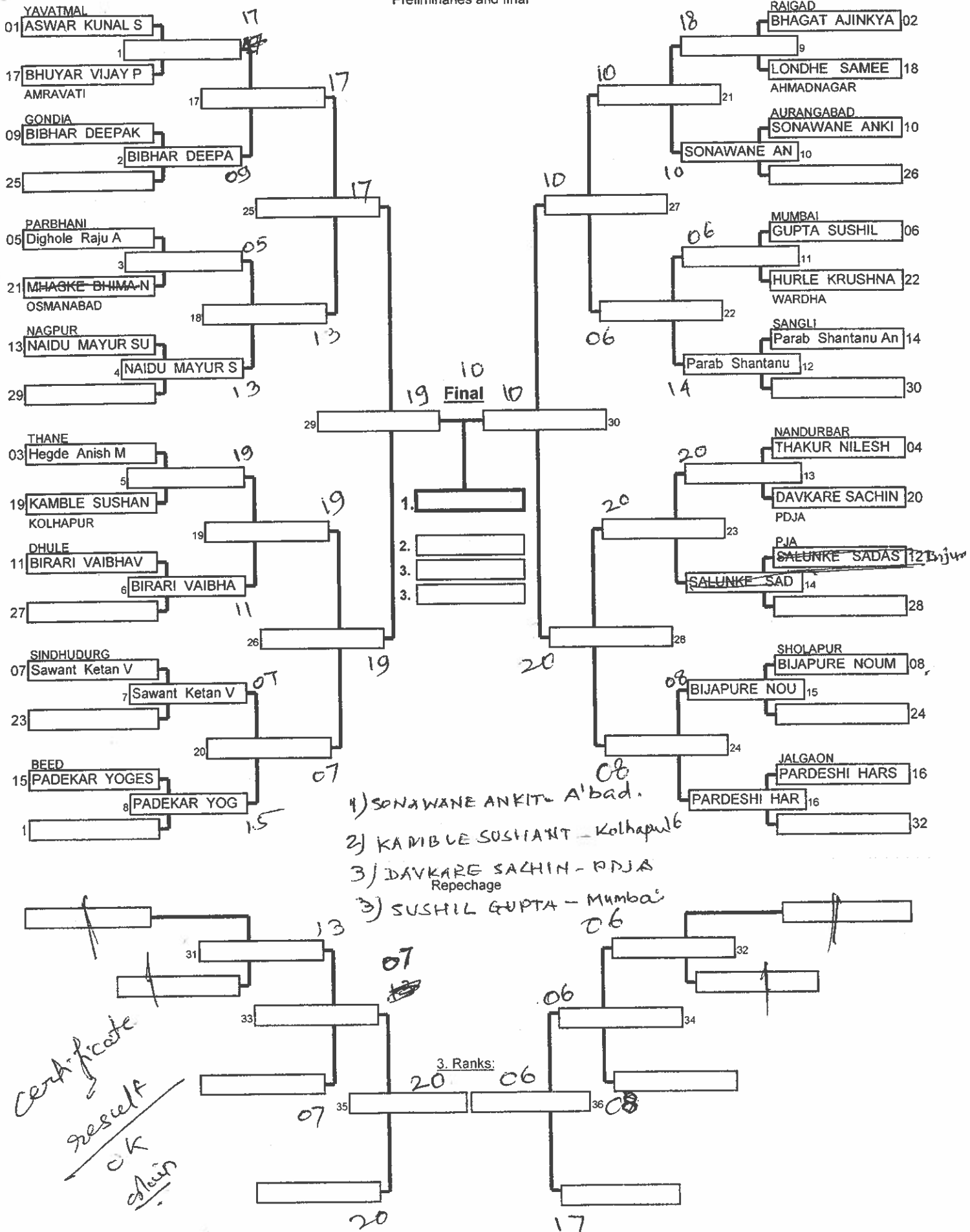

Preliminaries and final

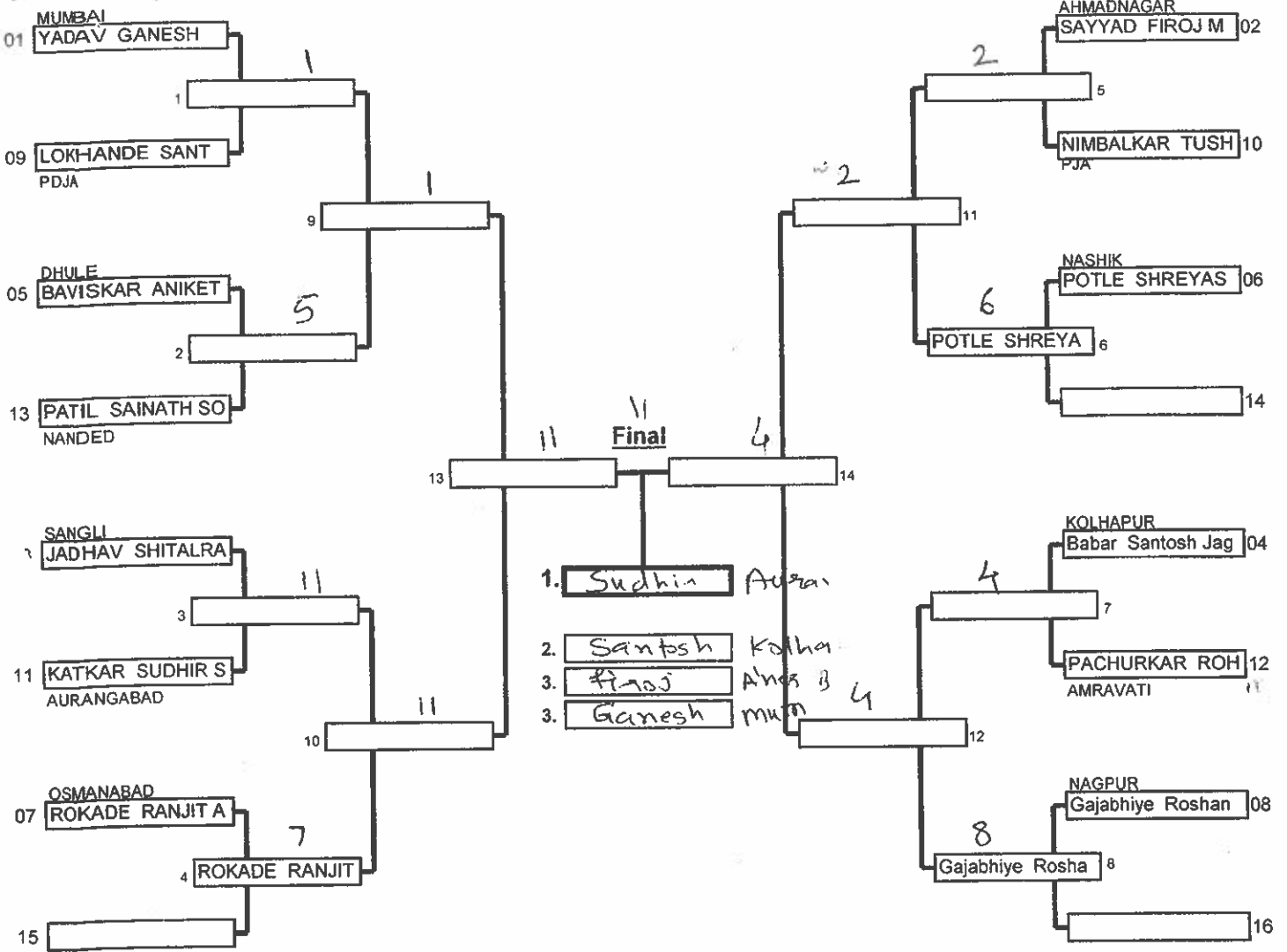

Repechage

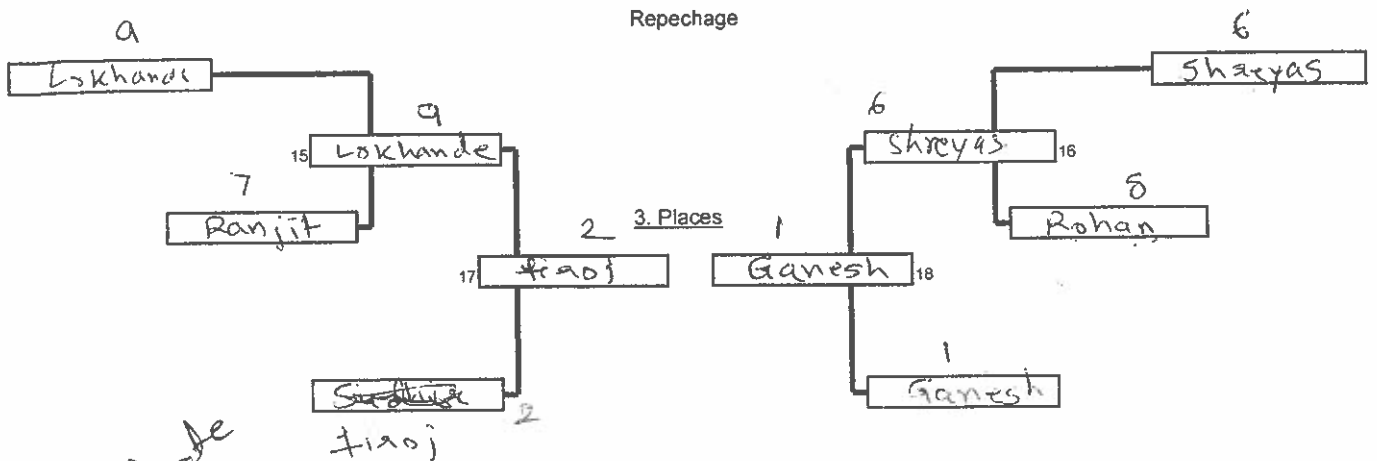

Certificate & Result OK

Preliminaries and final

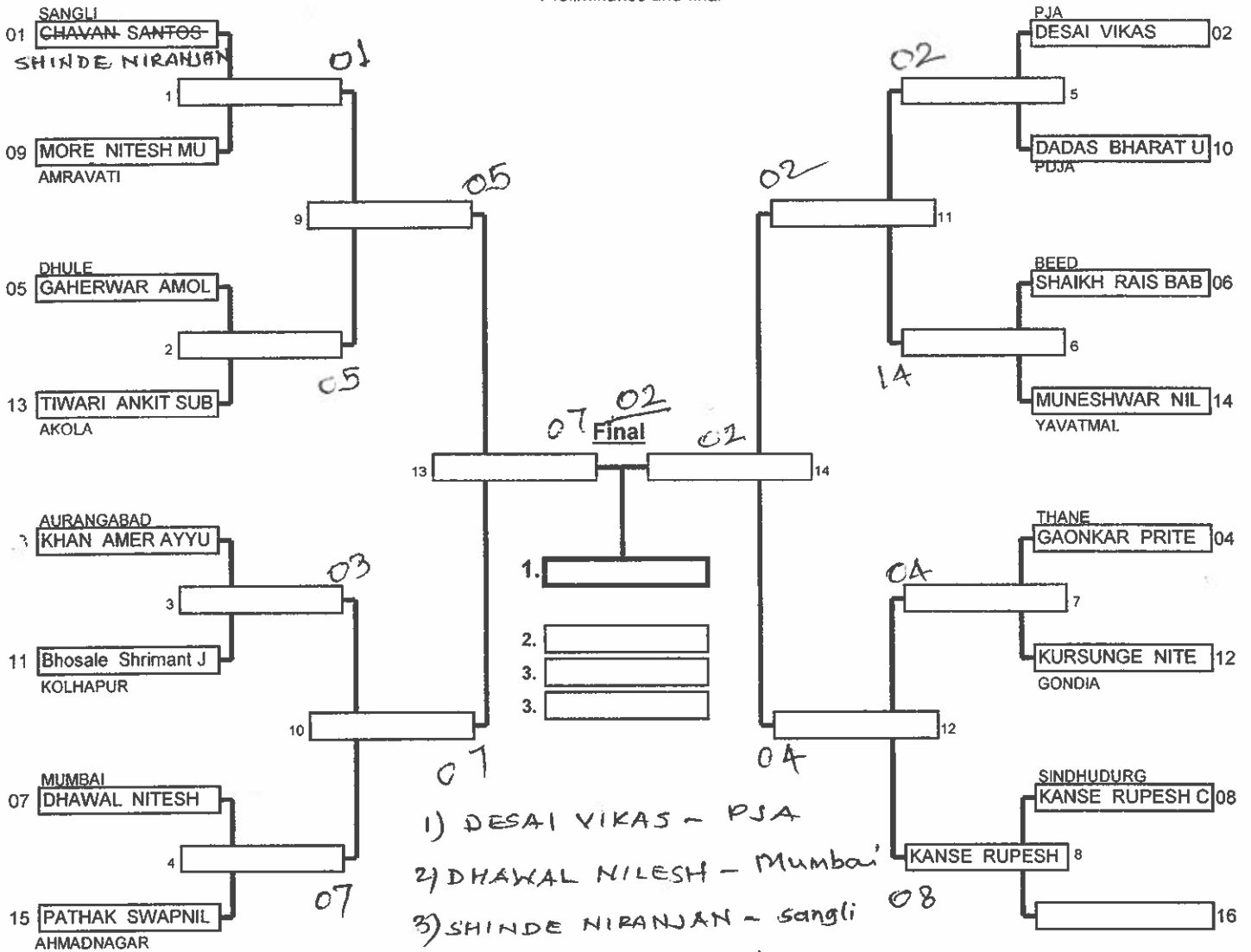

Repechage

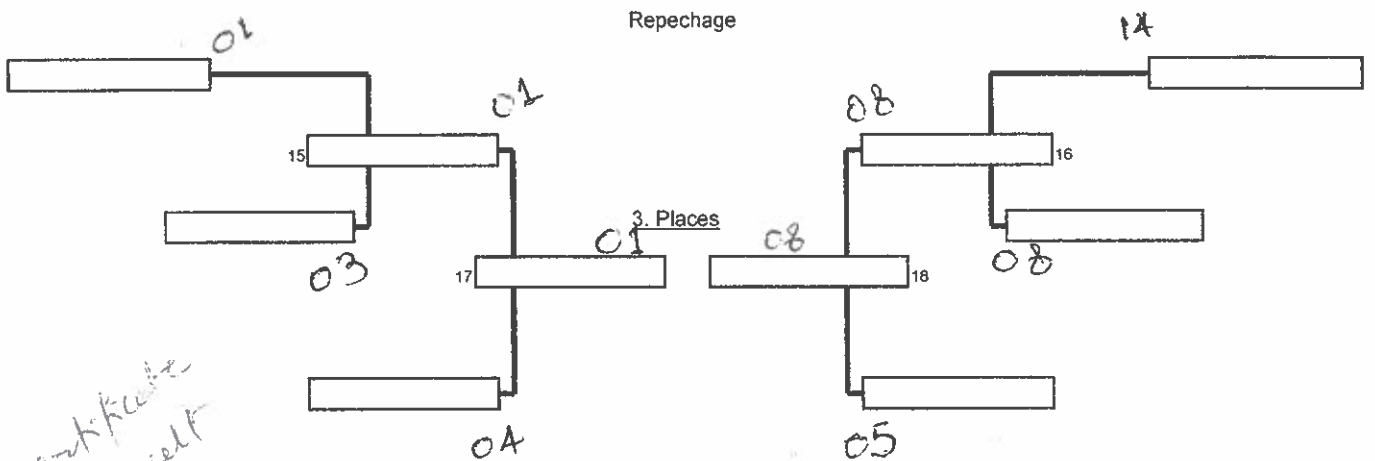

Certificate
 Request
 OK
 Date

B

Preliminaries and final

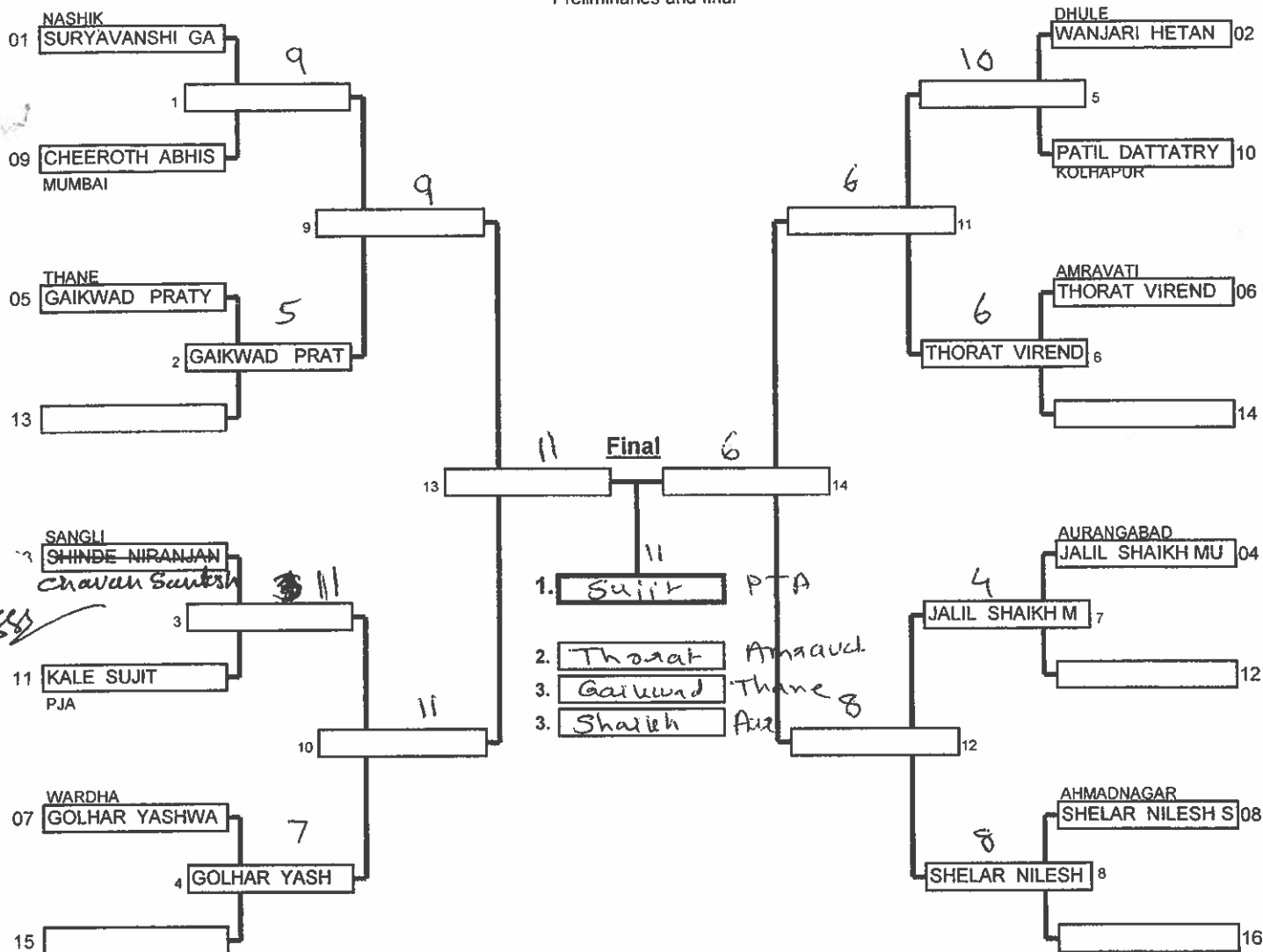

Repechage

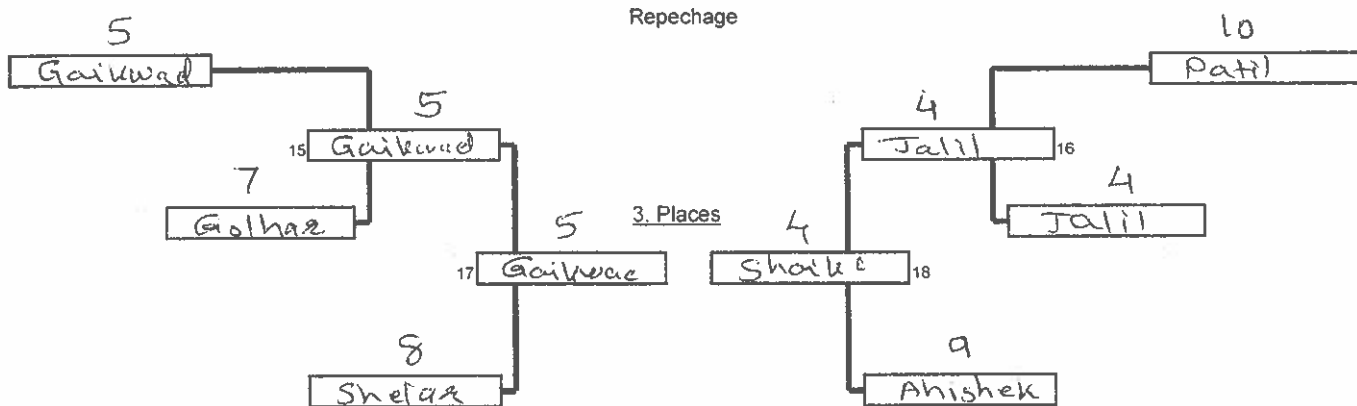

Result
 certificate
 OK
 Mr.

Preliminaries and final

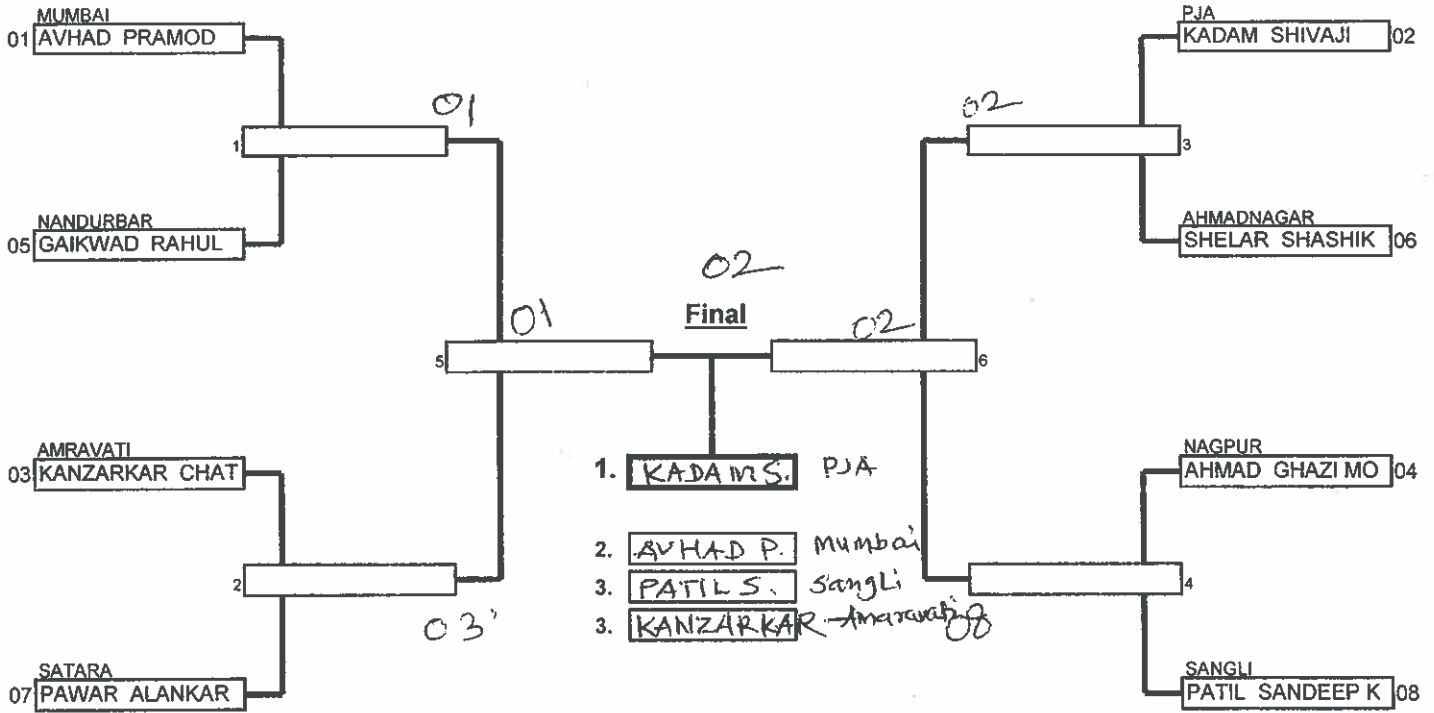

Repechage

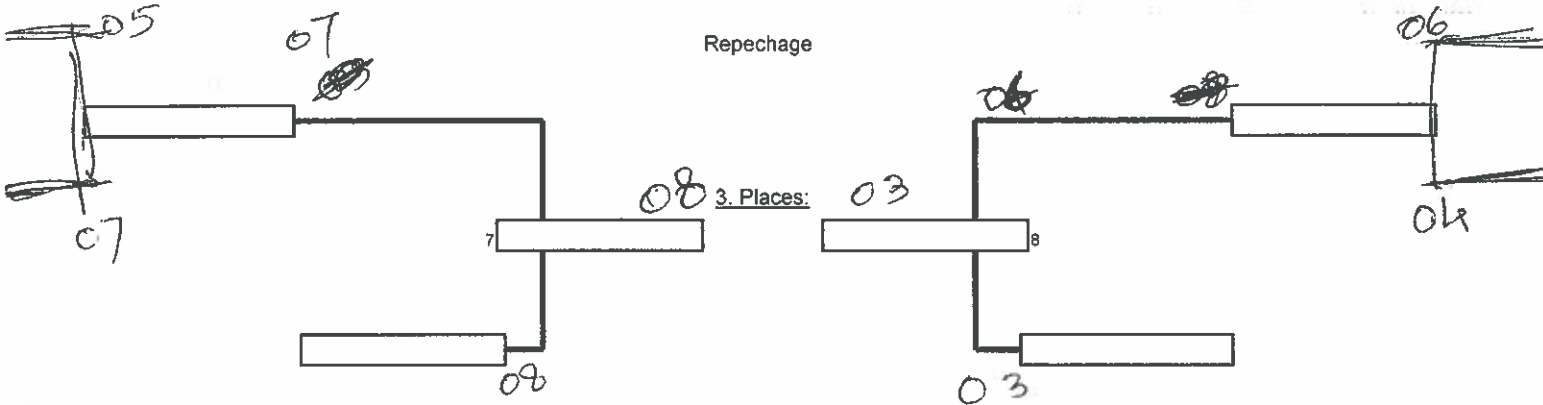

Certificate
 result
 written

