

MEN

56 KG

44TH SENIOR STATE J MEN

AMRAVATI

11/02/2017

21 Cmp.

Elimination System with Double Repechage for 17 to 32 Competitors

5 min

Matte

Preliminaries and final

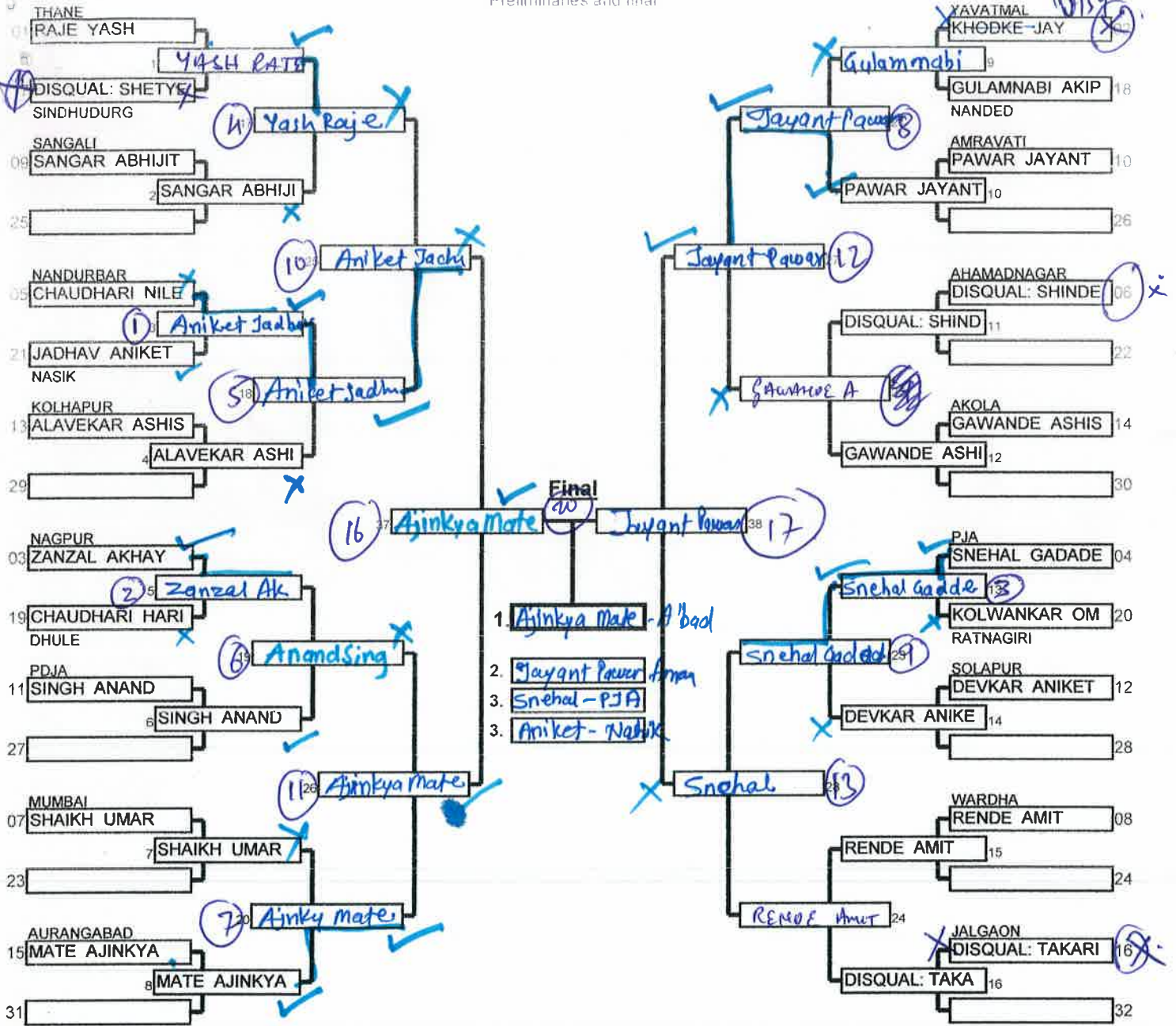

Repechage

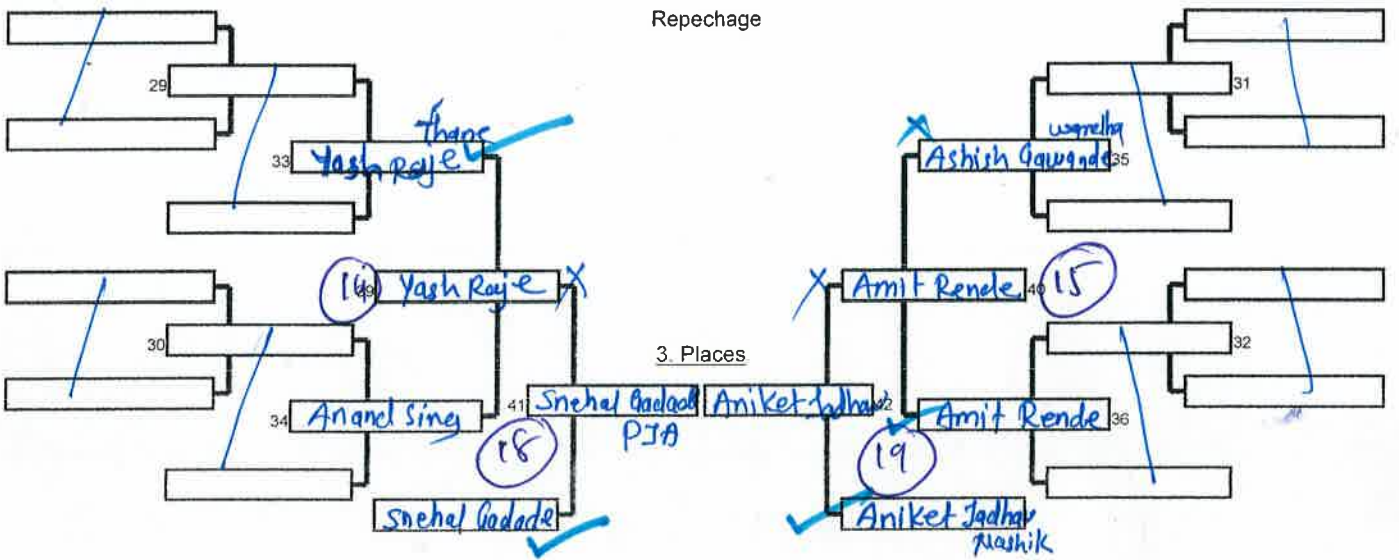

MEN

- 60 KG

44TH SENIOR STATE J MEN

AMRAVATI

11/02/2017

19 | Cmp.

Elimination System with Double Repechage for 17 to 32 Competitors

5 min

Matte

Preliminaries and final

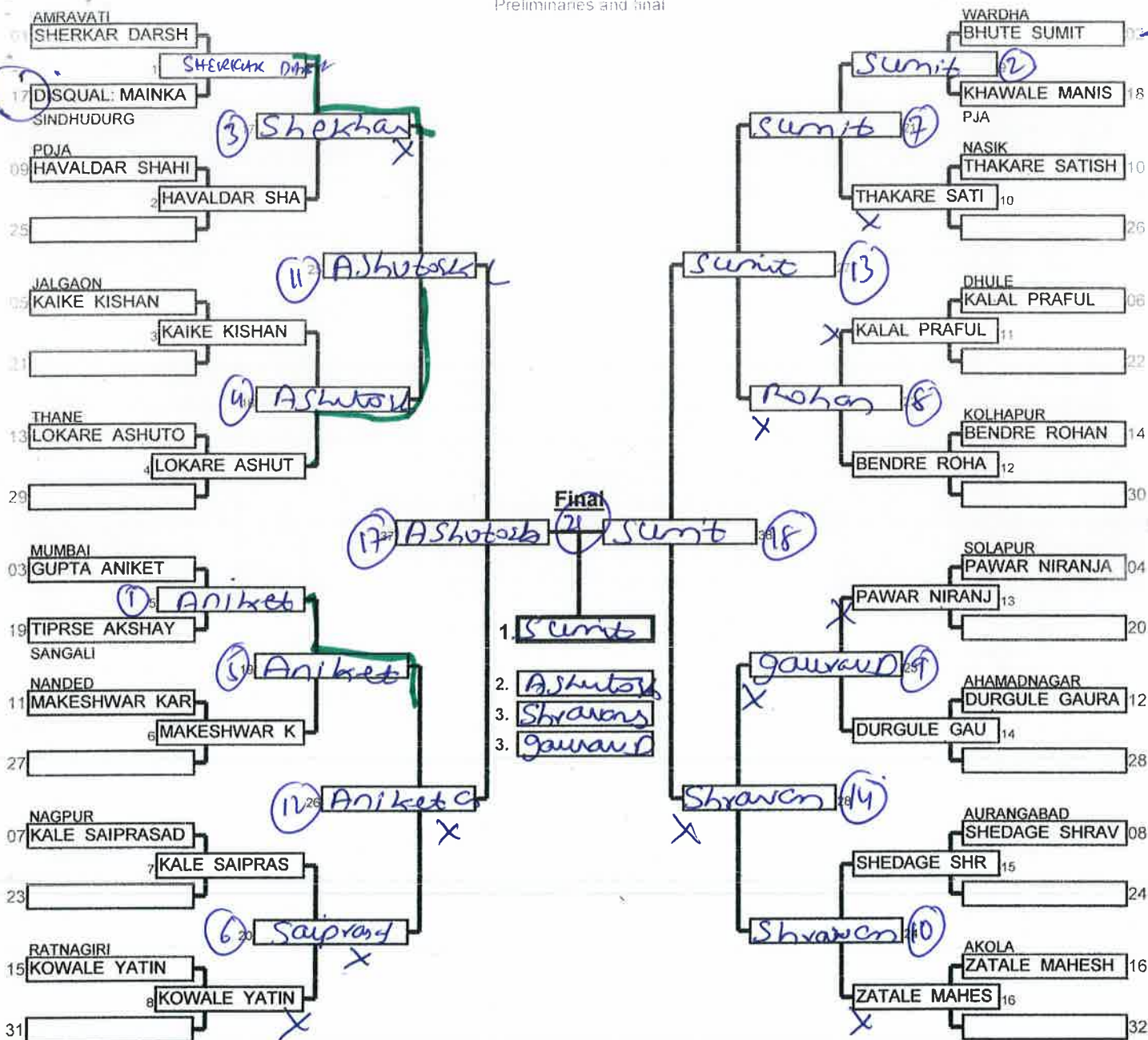

Repechage

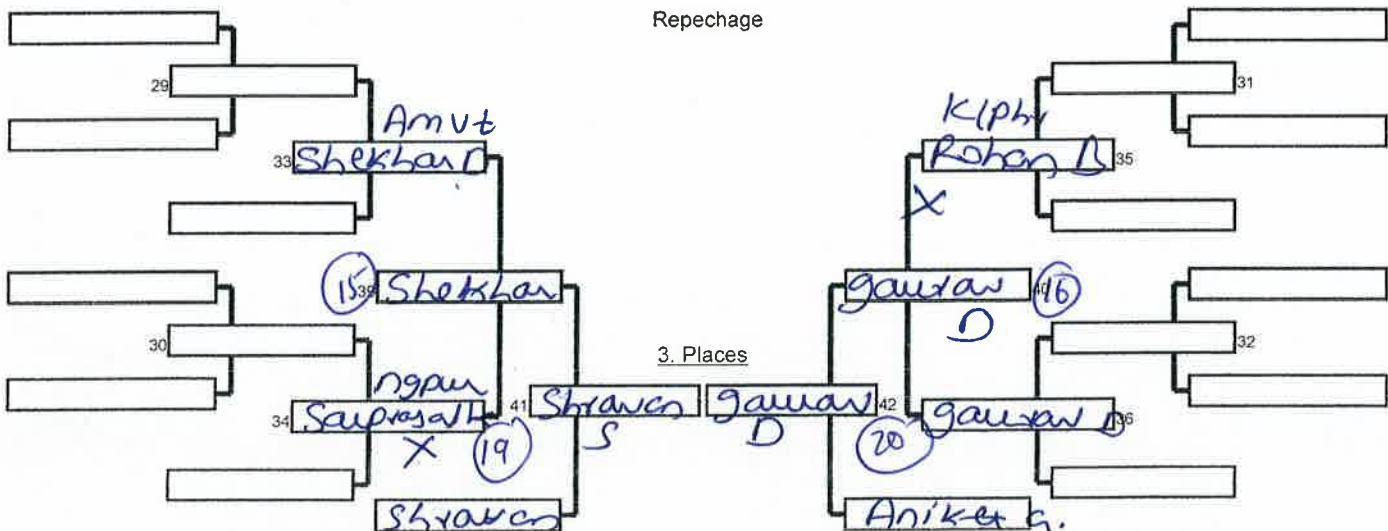

*[Handwritten signatures and marks]*

①

MEN

-66 KG

44TH SENIOR STATE J MEN

AMRAVATI

11/02/2017

21 Cmp.

Elimination System with Double Repechage for 17 to 32 Competitors

5 min

Matte

Preliminaries and final

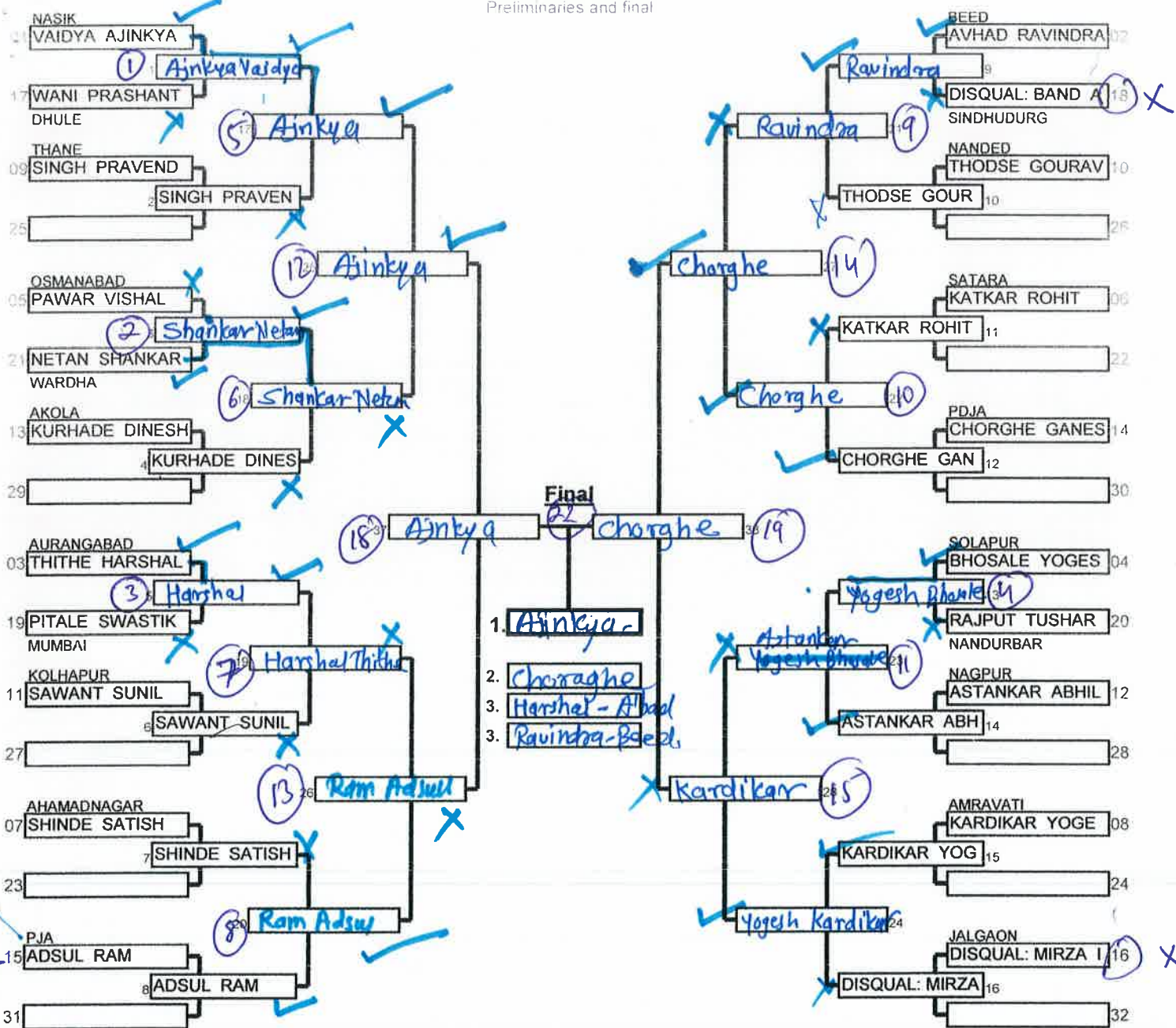

Repechage

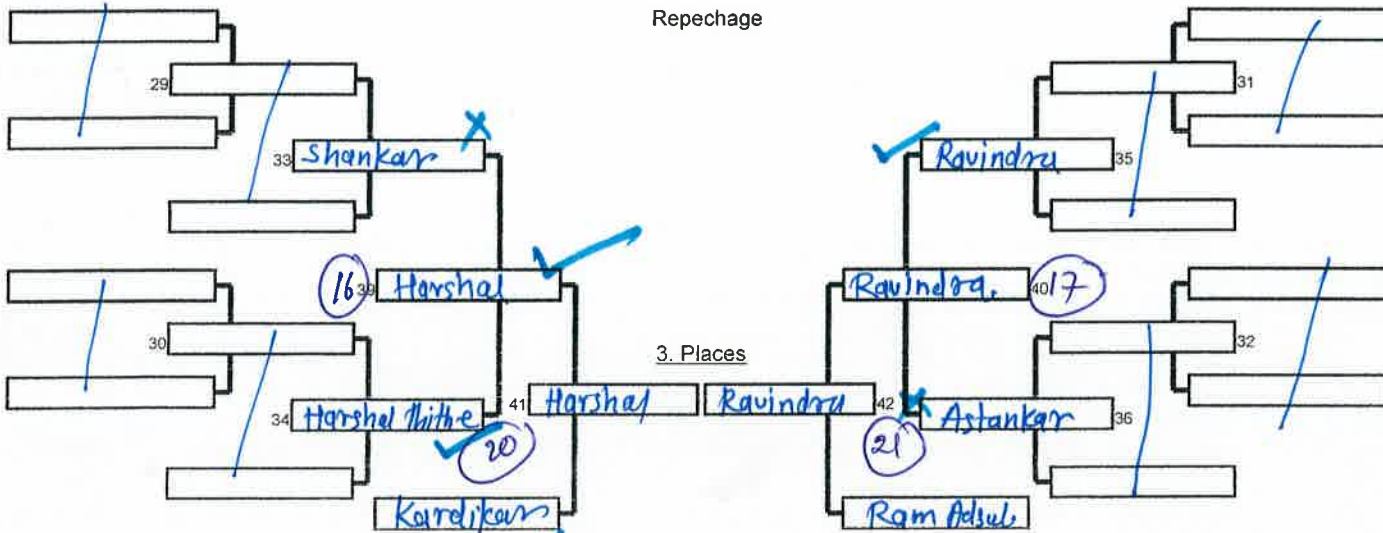

MEN	73 KG	44TH SENIOR STATE J MEN	AMRAVATI	11/02/2017	22 Cmp.
Elimination System with Double Repechage for 17 to 32 Competitors				5 min	Matte

Preliminaries and final

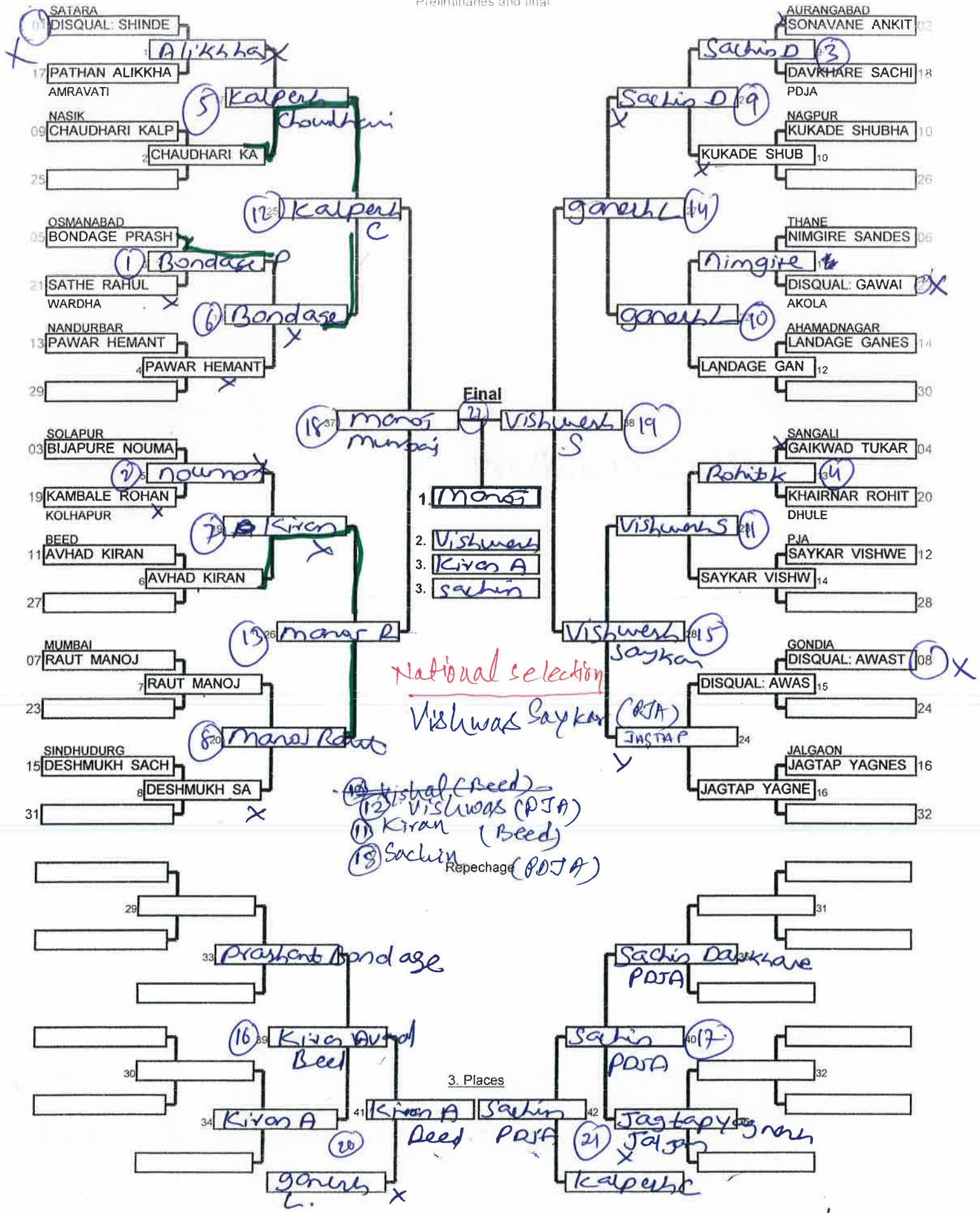

*Handwritten signatures and notes:*

- Large blue scribbles at the bottom center.
- Signature "Prashant" in blue ink at the bottom right.
- Signature "Sachin" in blue ink at the bottom right.
- Handwritten "2" in a circle at the bottom right corner.

Men ~~70 kg~~ - 73 kg

I 0 4  
O O Δ

National selection

- 1) Vishwas <sup>were</sup> Saykar (PJA)
- 2) Kiran Avhad (Beed)
- 3) Sachin Dawkhare (PDJA)

Selected  
National

1x0      2x0      3x0  
 2x3      3x1      1x2

	Vishwas Saykar	Kiran Avhad	Sachin D	Total
Vishwas Saykar	X	O	O	I
Kiran A	Δ	X	Δ	III
Sachin D	⊙ Δ	O	X	II

Vishwas Saykar (PJA) (selected for National)

  
  
 (Varsing)

  
PJA

MEN

-81 KG

44TH SENIOR STATE J MEN

AMRAVATI

11/02/2017

20 Cmp.

Elimination System with Double Repechage for 17 to 32 Competitors

5 min

Matte

Preliminaries and final

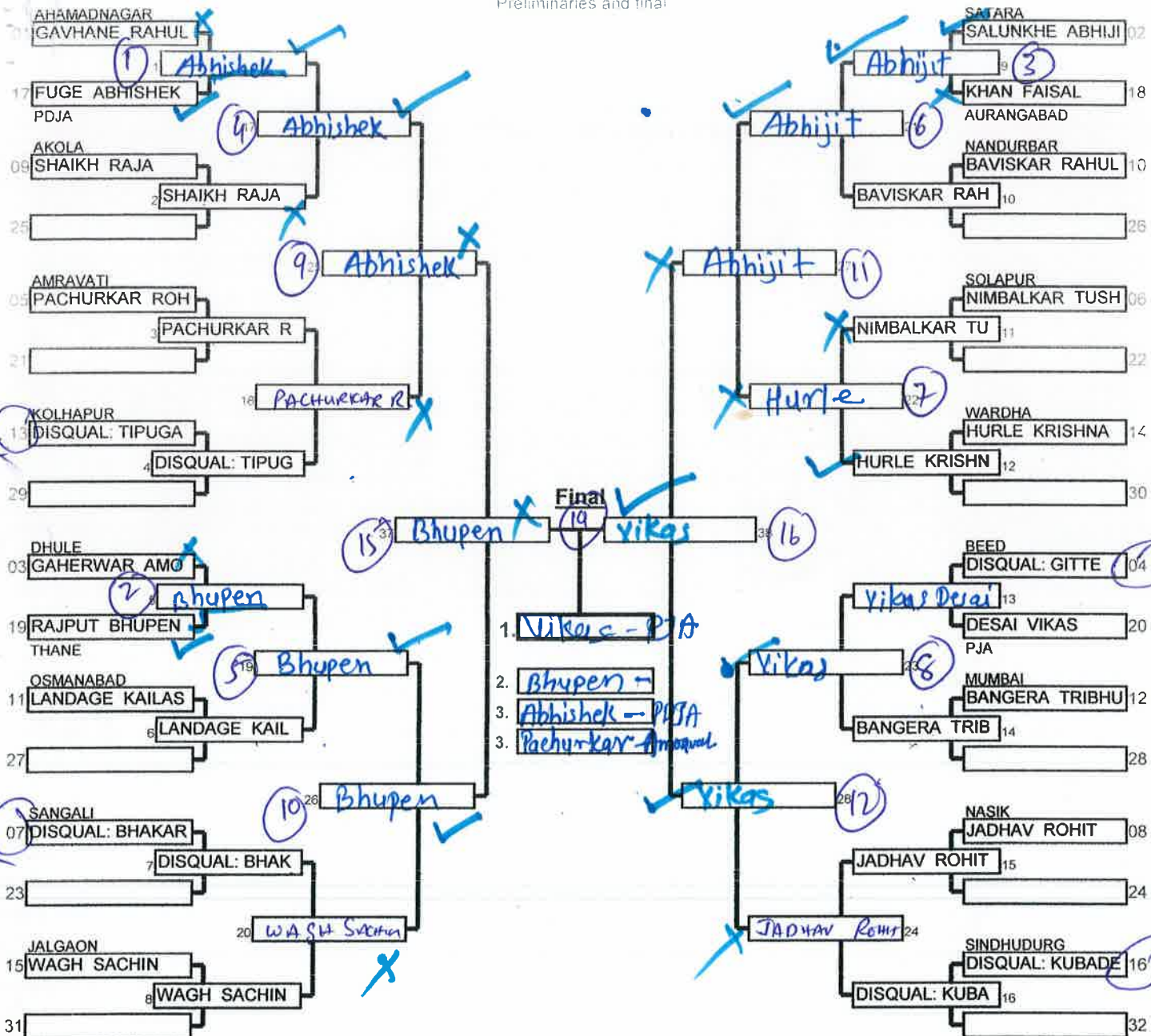

Repechage

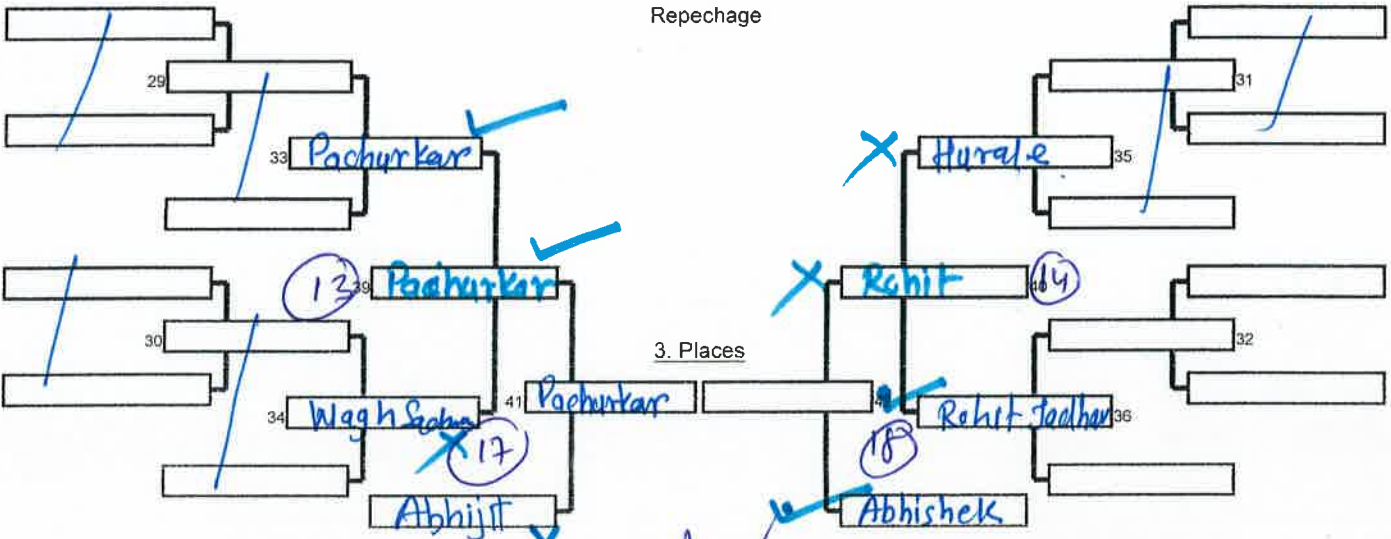

*(Handwritten signatures and marks)*  
 PJA  
 (4)

MEN

- 90 KG

44TH SENIOR STATE J MEN

AMRAVATI

11/02/2017

15 | Cmp.

Elimination System with Double Repechage for 9 to 16 Competitors

5 min

Matte

Preliminaries and final

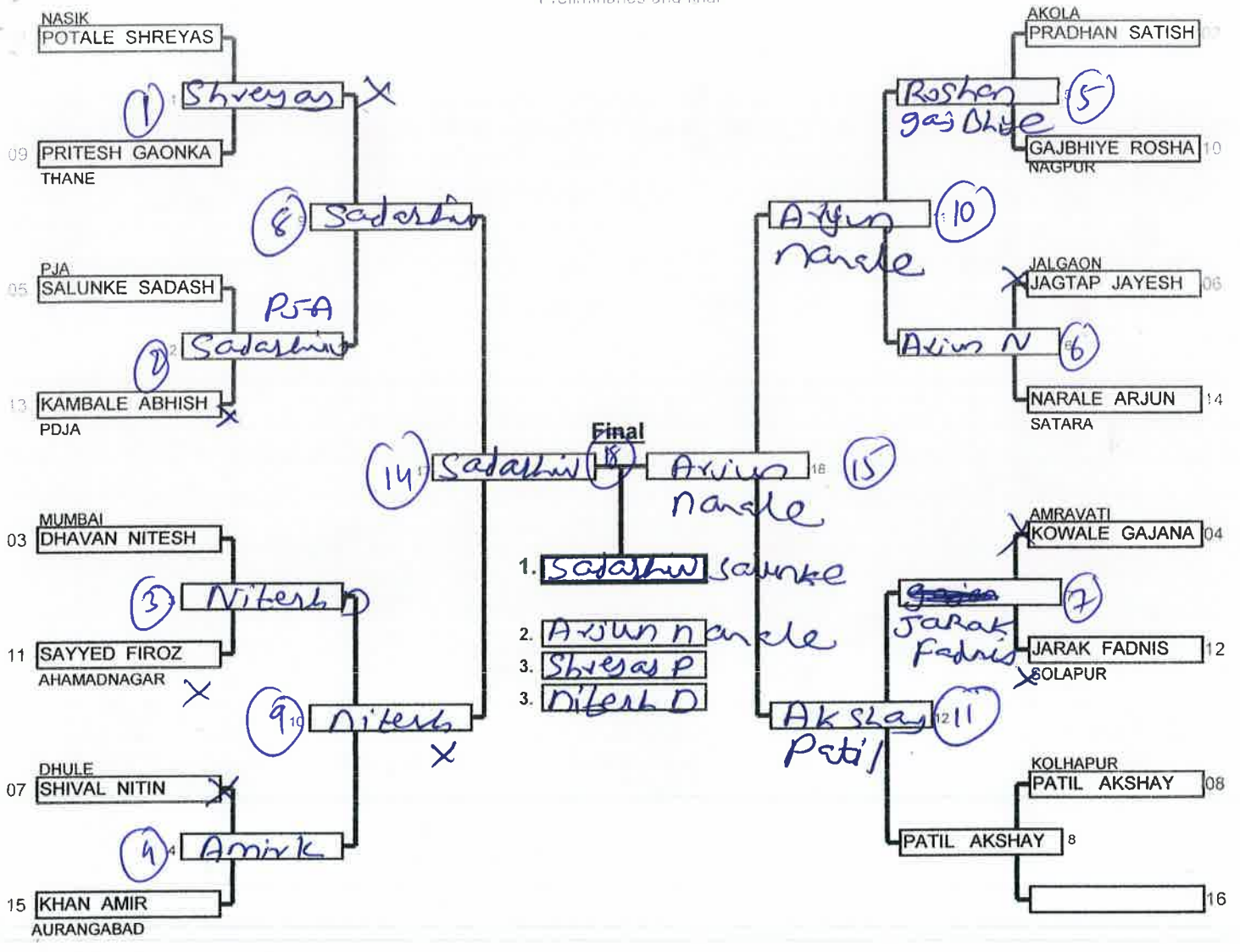

Repechage

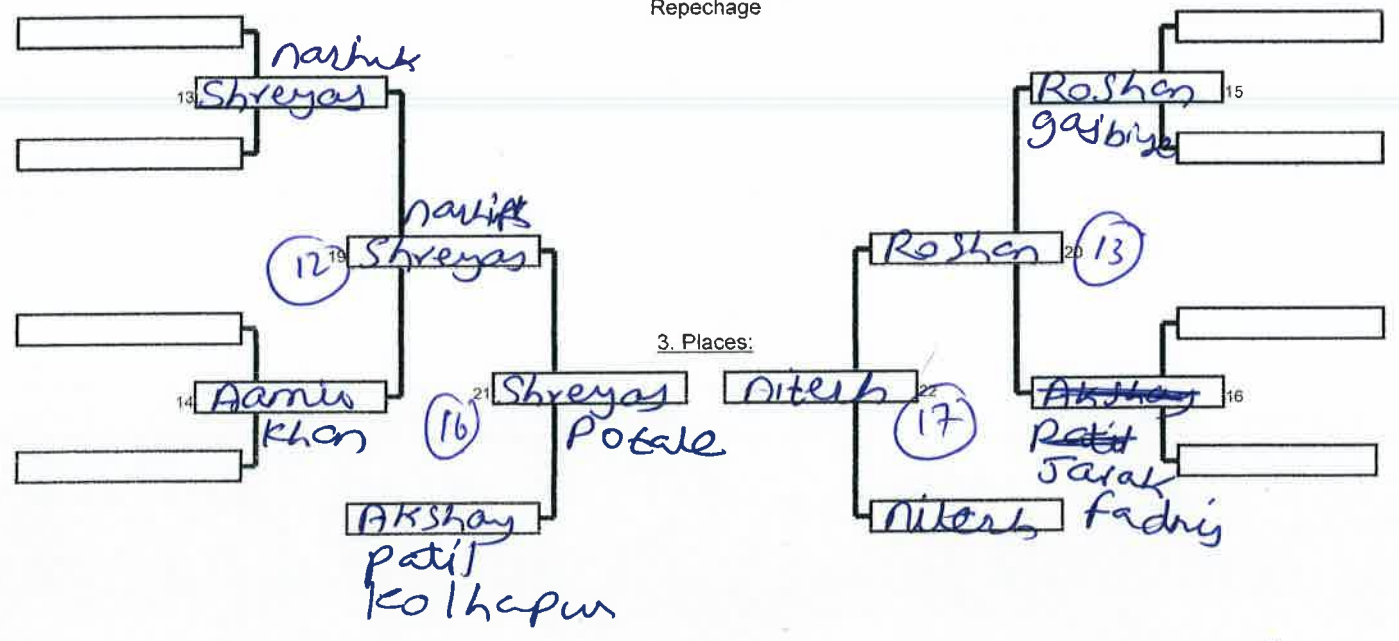

*[Handwritten signatures and initials]*

*[Handwritten initials: PJA]*

MEN

- 100 KG

44TH SENIOR STATE J MEN

AMRAVATI

11/02/2017

13 Cmp.

Elimination System with Double Repechage for 9 to 16 Competitors

5 min

Matte

MAT-1

MVB

Preliminaries and final

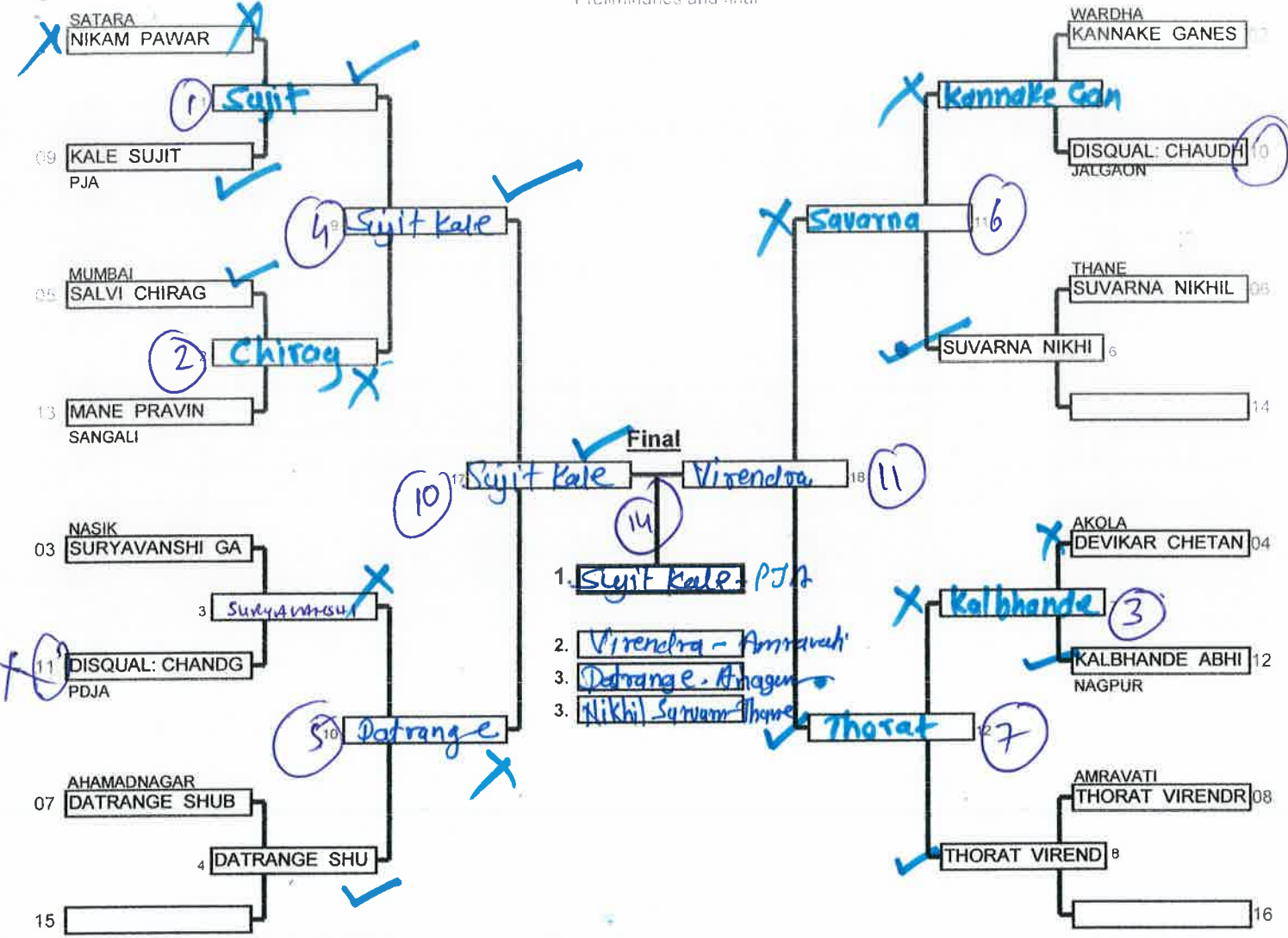

Repechage

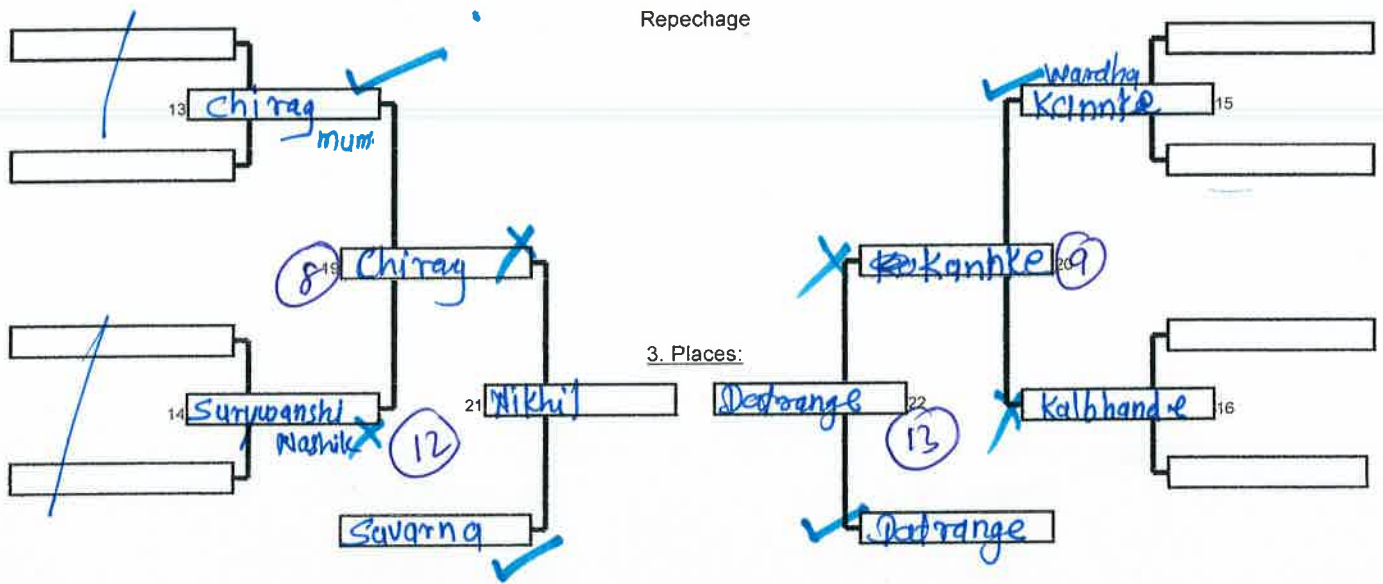

*[Handwritten signatures and marks]*

2



MAT - 2

(M/S)

Preliminaries and final

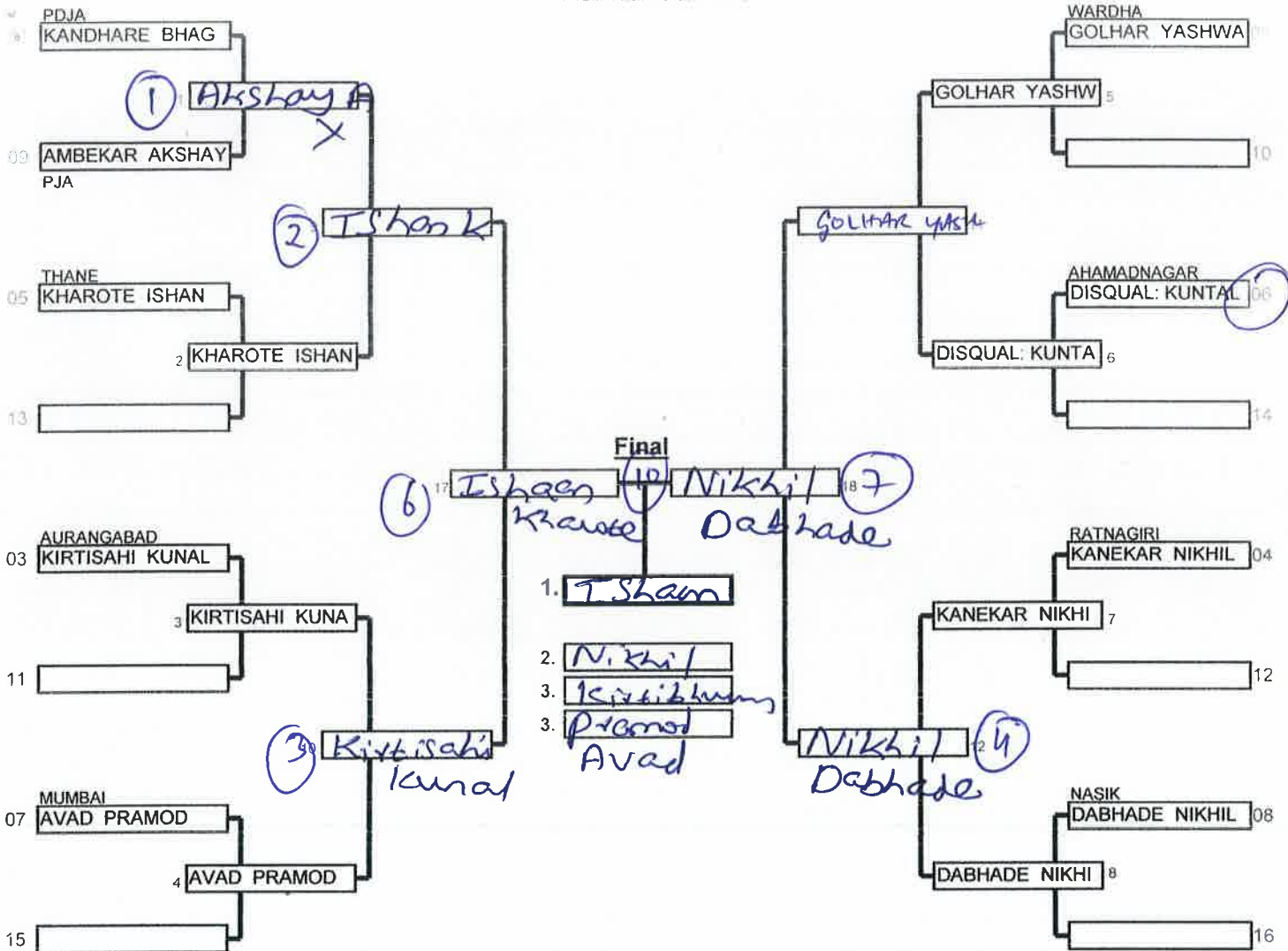

Repechage

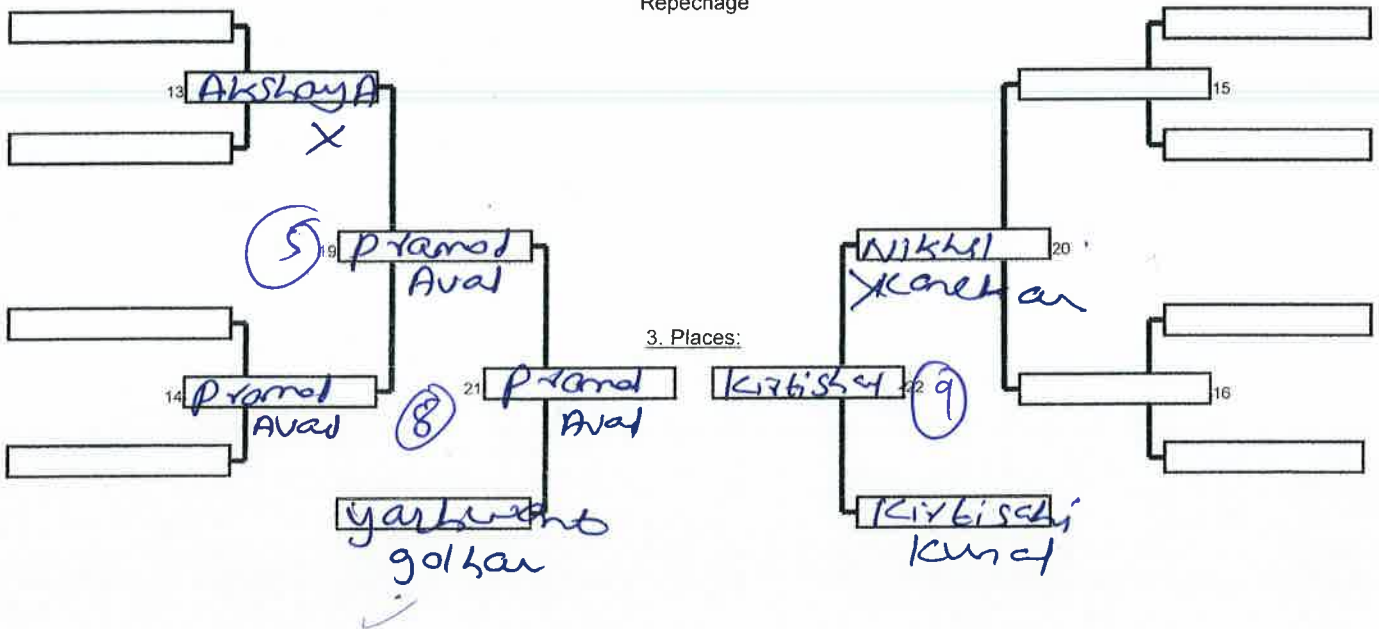

*[Handwritten signatures and marks]*

850

①

MAT - 3

MS

Preliminary and final

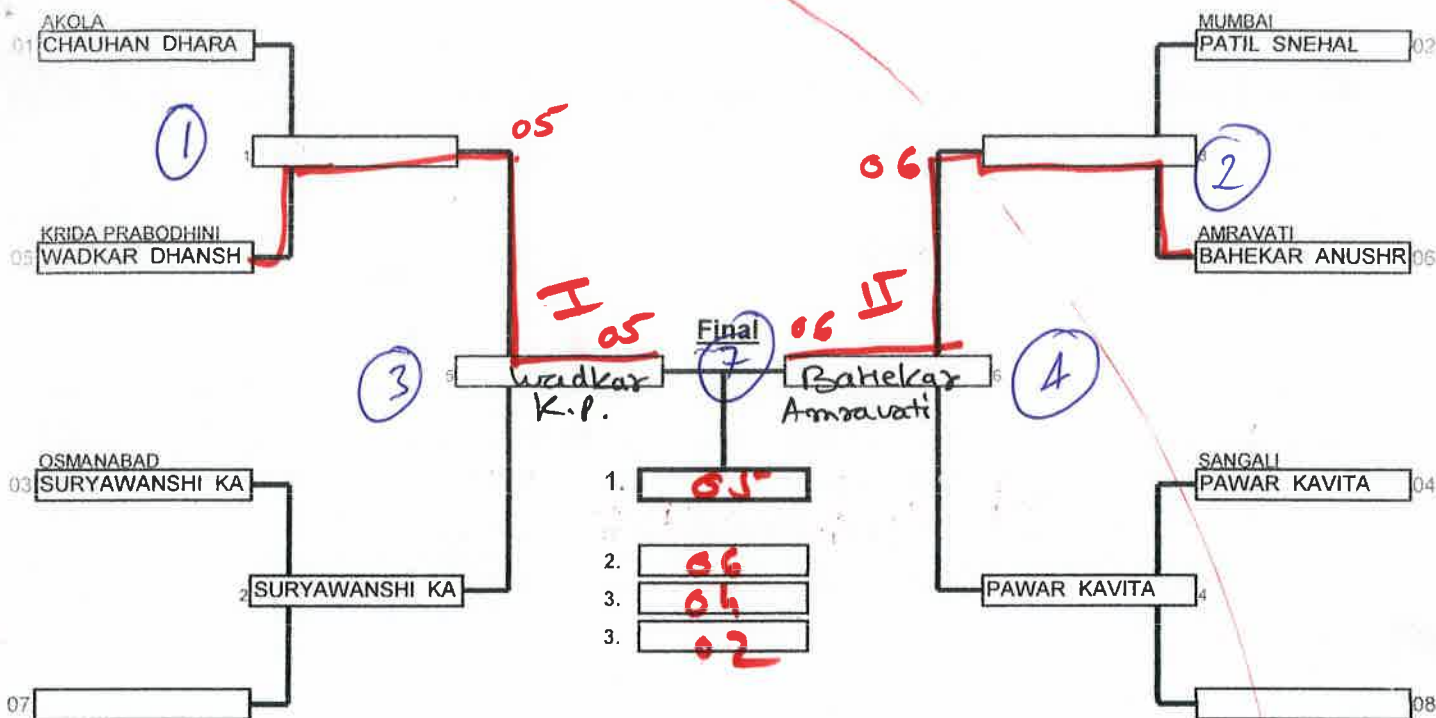

Repechage

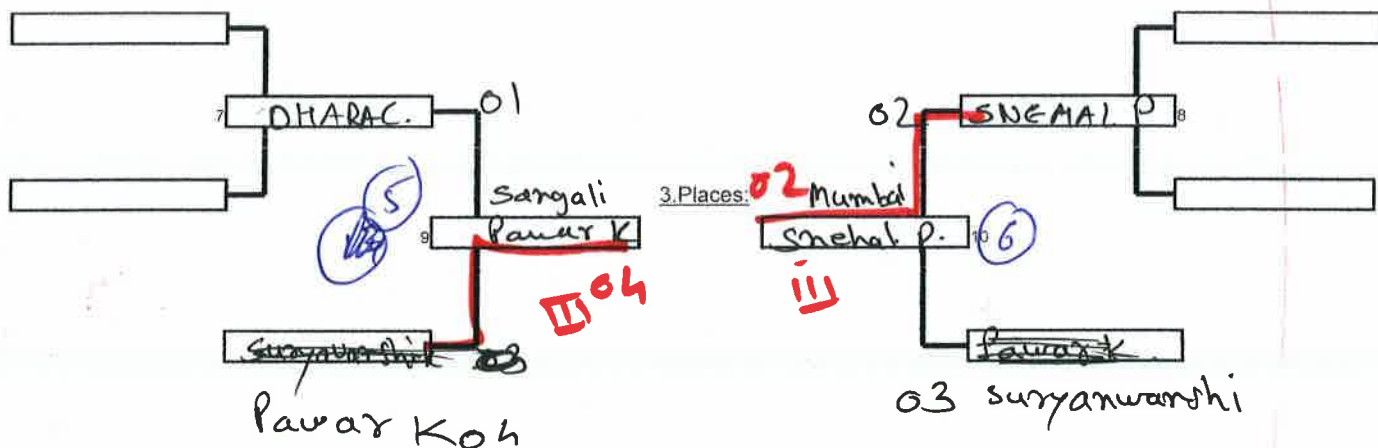

- I WADKAR DHANSHREE KP.
- II BAHEKAR ANUSHREE Amravati
- III Pawar Kavita Sangali
- IV Snehal Patil Mumbai

Preliminaries and final

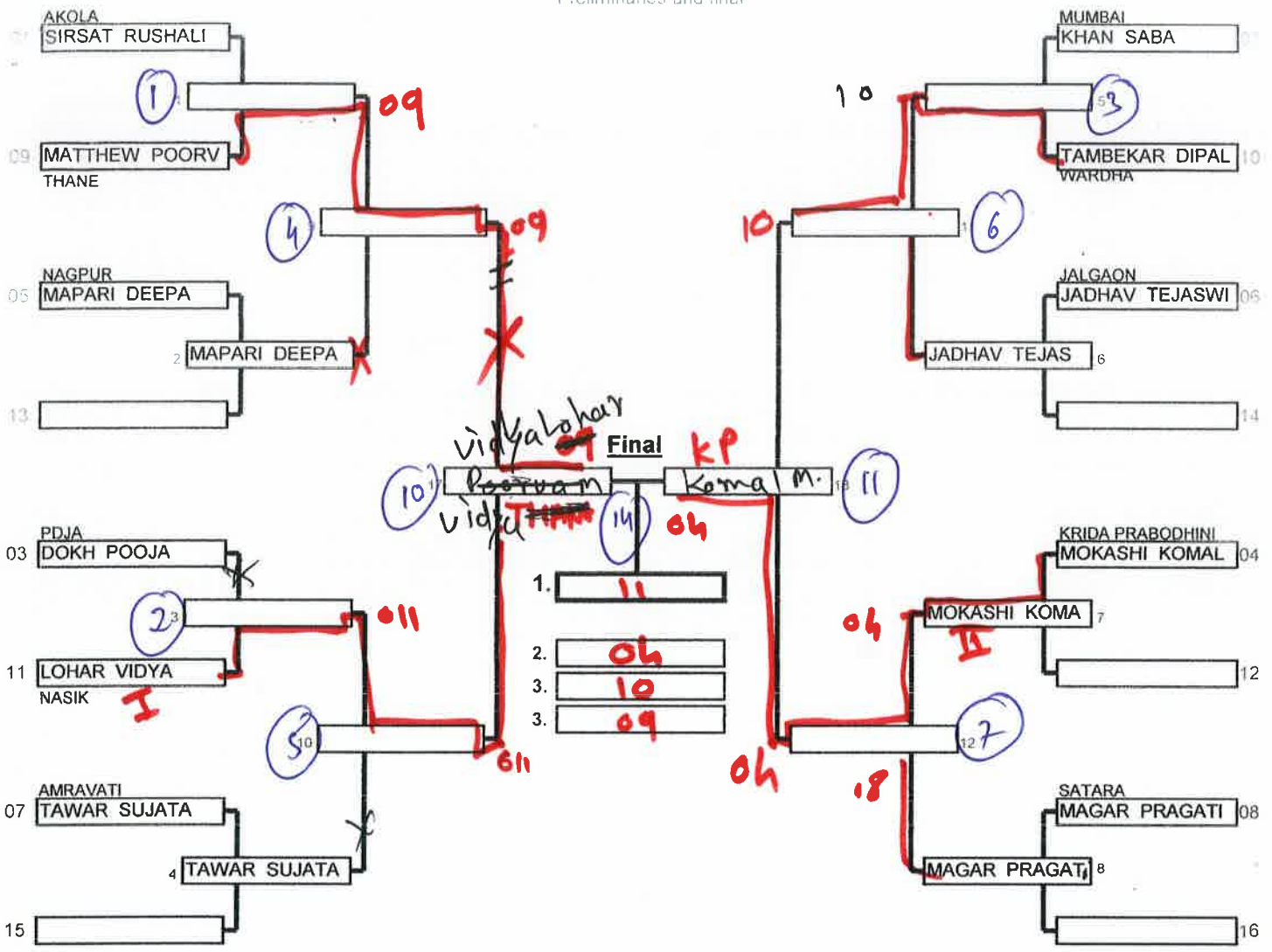

Repechage

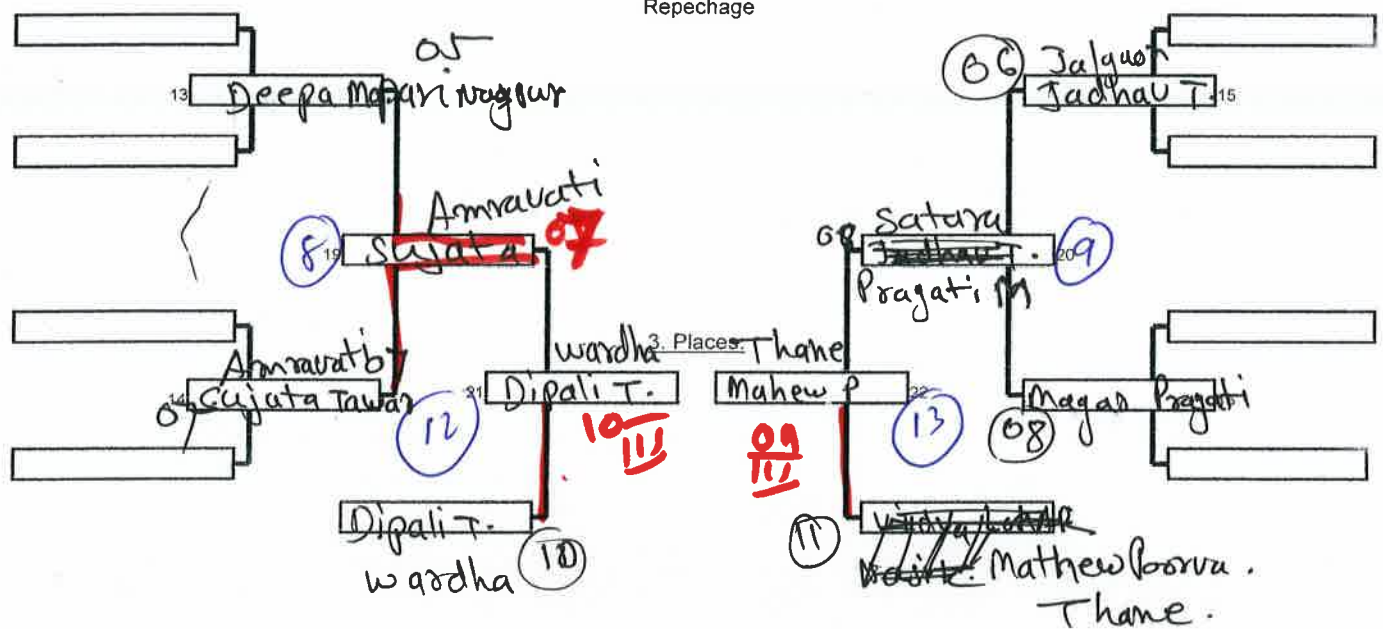

*Handwritten signature and notes:*

Mathew Poorva Thane.

*[Signature]*

MAT-3

MR

Preliminaries and final

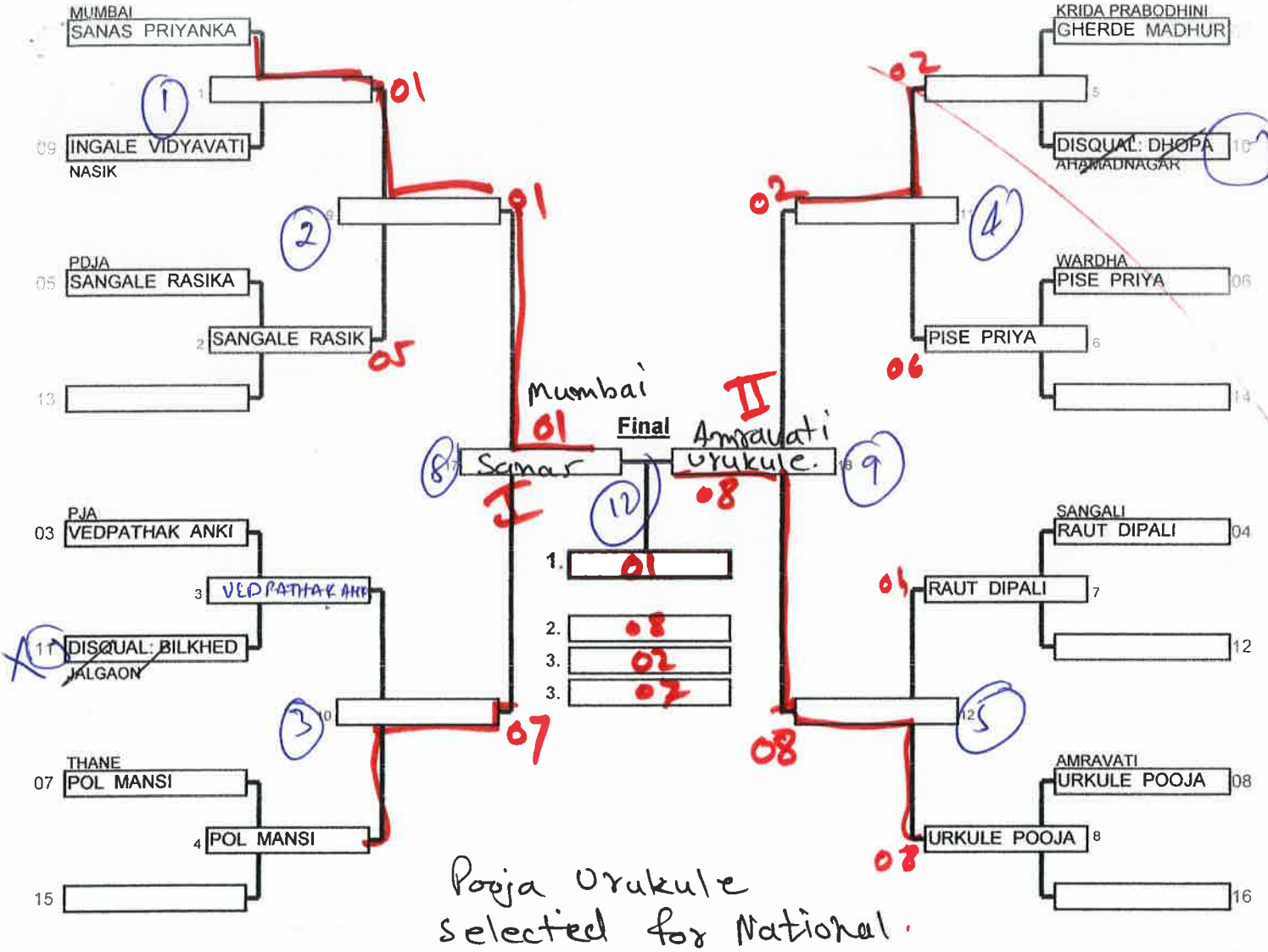

Repechage

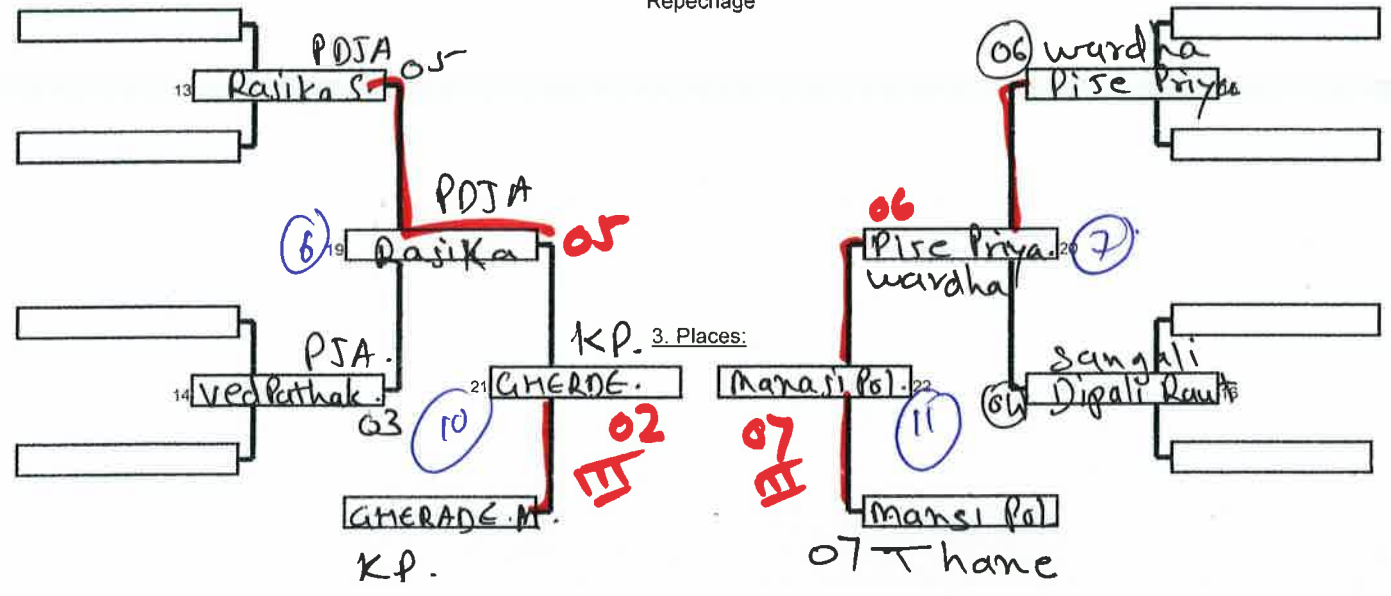

*Handwritten signatures and notes at the bottom of the page, including a large signature on the right and some scribbles at the bottom center.*

**— 52 kg women  
selection**

~~Sanas Piyanka~~

- 1) URUKULE Pooja
- 2) MADHURI GHERADE
- 3) MANASI POL

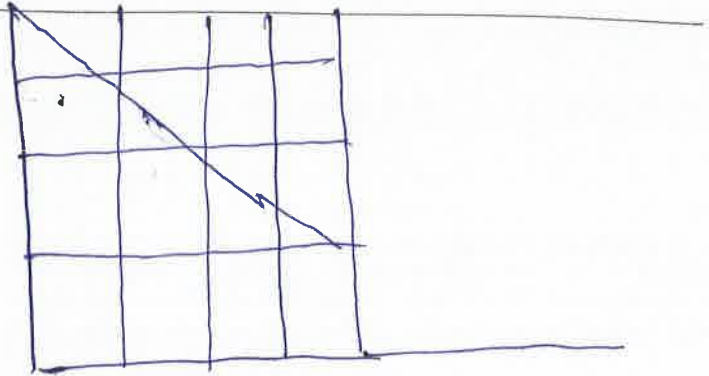

1 - X      2 - X      3 - X  
 ✓ 2 - 3      3 - 1      1 - 2

1      2      3      Total

1) URUKULE Pooja	Amravati			1	
2) Madhuri GHERADE	K.P.			1	
3) Manasi Pol	Thane.	X	X		

*pk*

*Prakash  
8/5/20*

MAT-3

MU

WOMEN

- 57 KG

44TH SENIOR STATE J WOMEN

AMRAVATI

11/02/2017

12 Cmp.

Elimination System with Double Repechage for 8 to 16 Competitors

4 min

Matte

Preliminaries and final

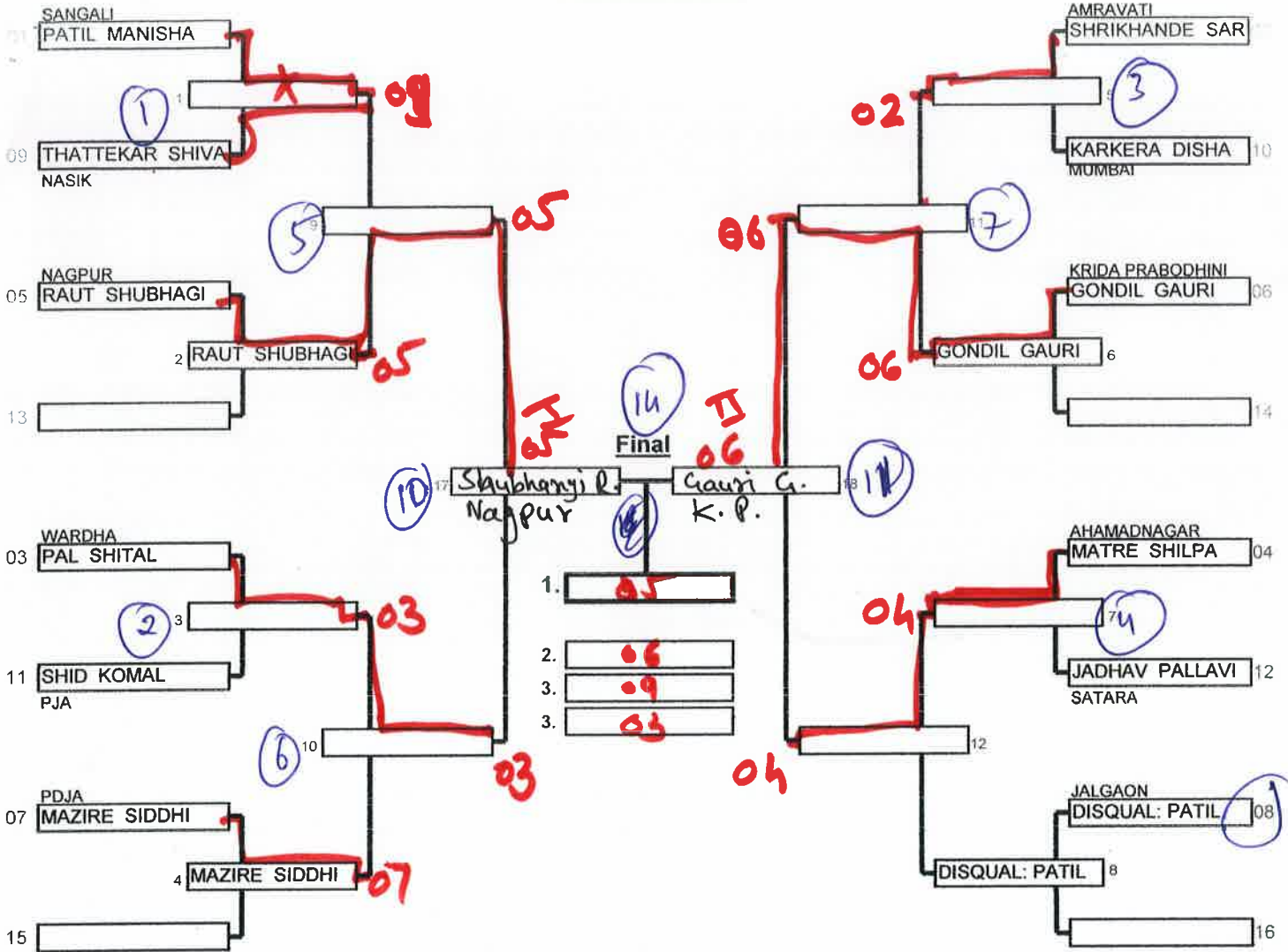

Repechage

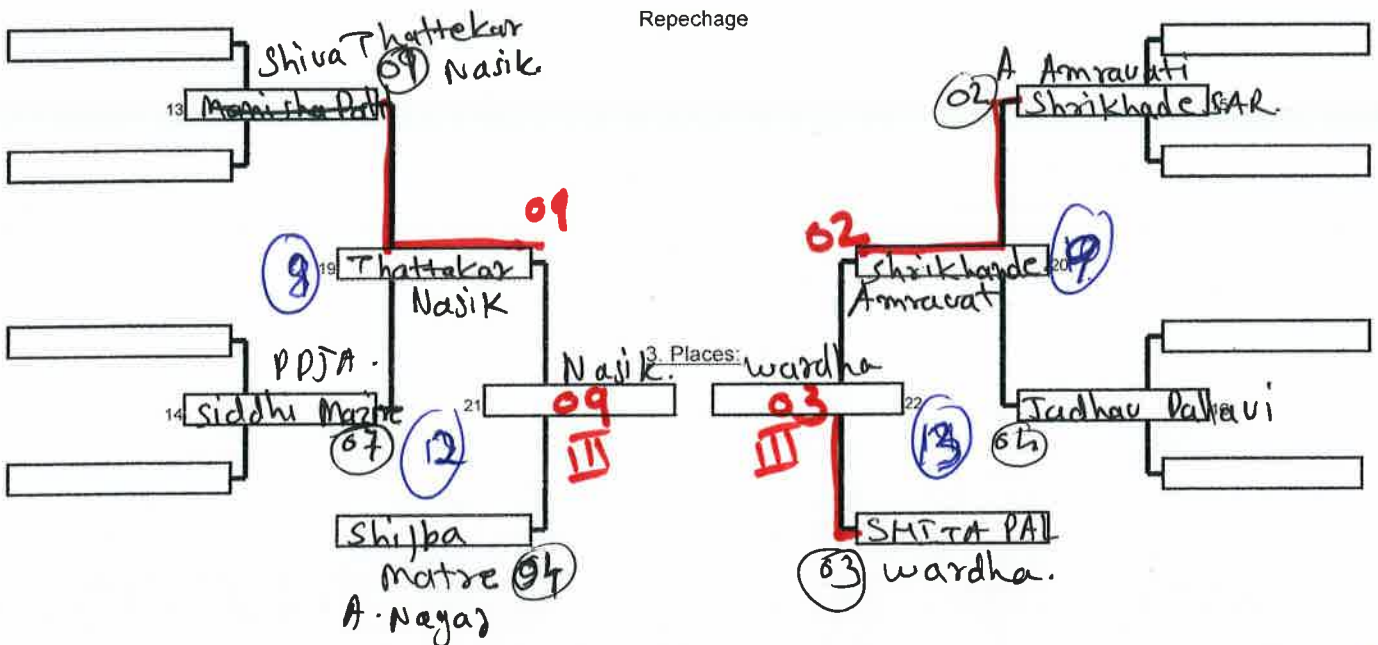

*Handwritten signature and initials*

WOMEN

- 63 KG

44TH SENIOR STATE J WOMEN

AMRAVATI

11/02/2017

10 Cmp

Elimination System with Double Repechage for 9 to 16 Competitors

4 min

Matte

Preliminaries and final

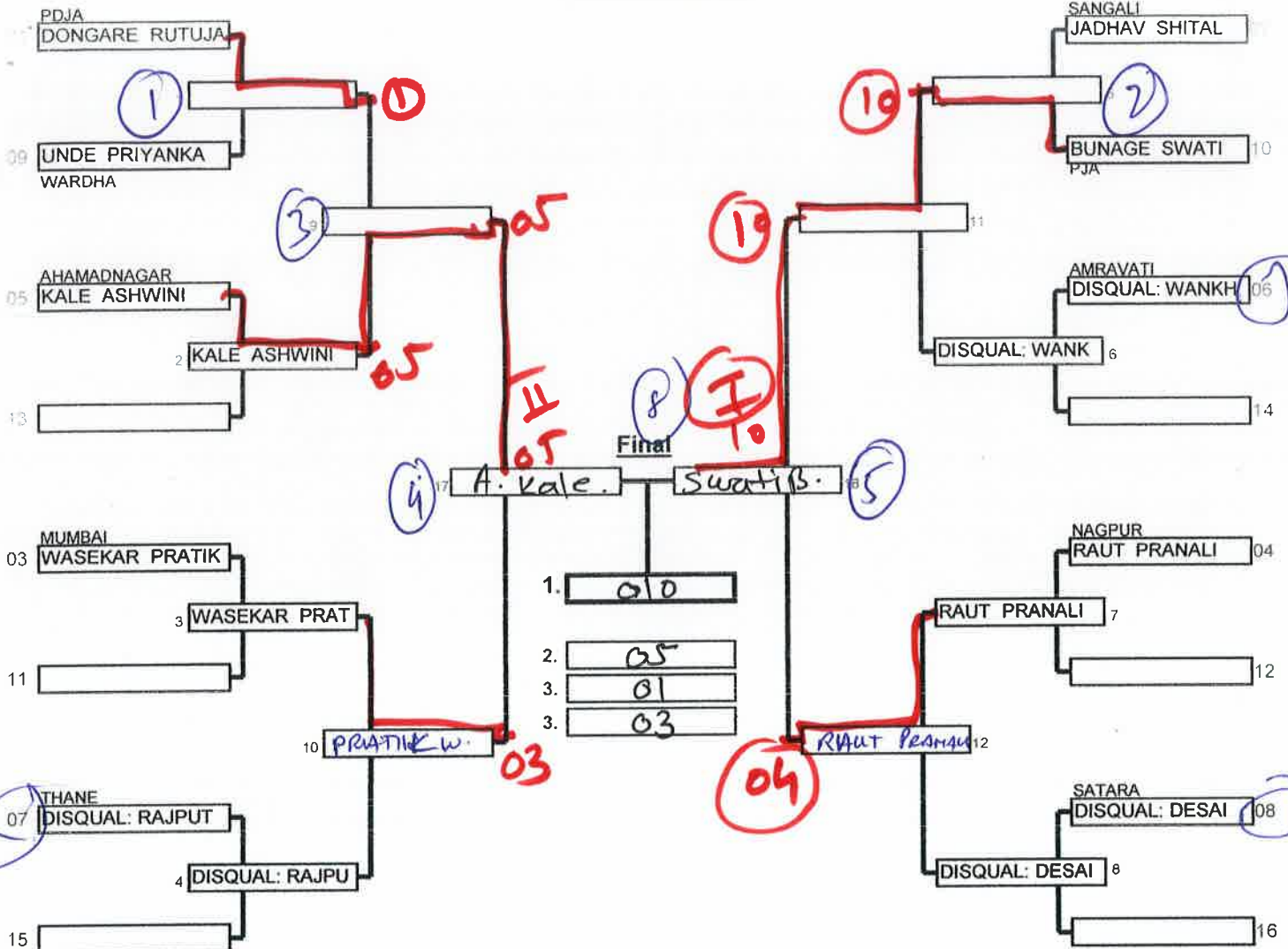

Repechage

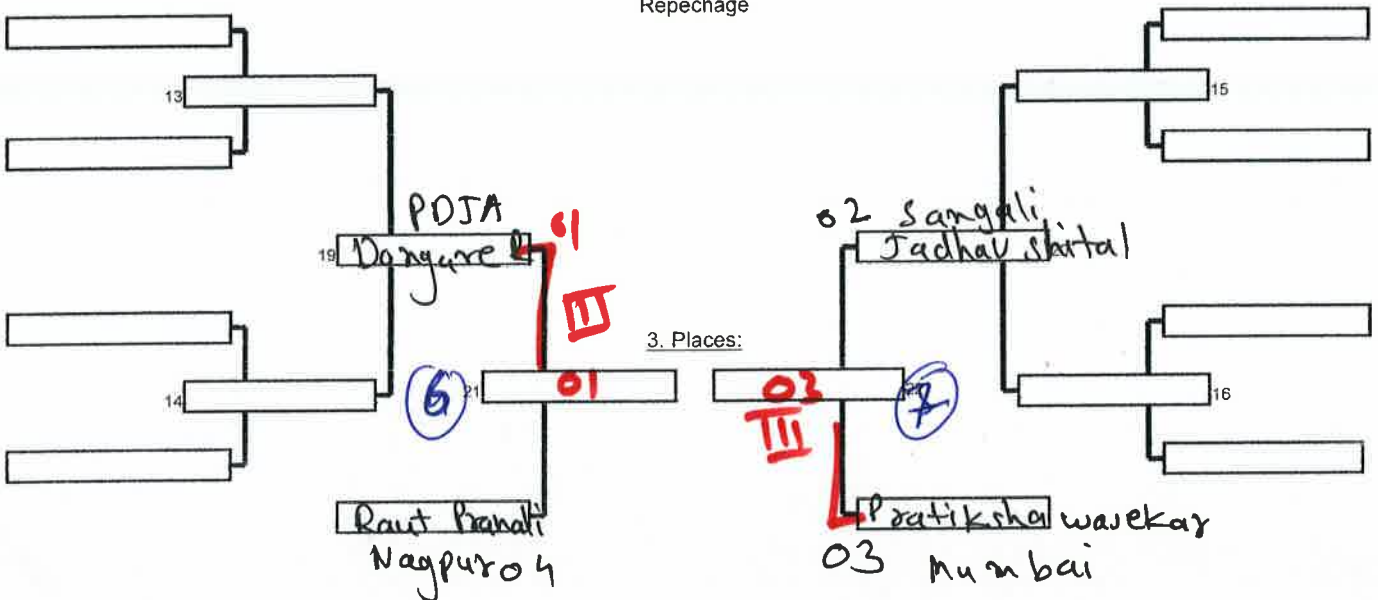

WOMEN

- 70 KG

44TH SENIOR STATE J WOMEN

AMRAVATI

11/02/2017

10 Cmp.

Elimination System with Double Repechage for 9 to 16 Competitors

4 min

Matte

Preliminaries and final

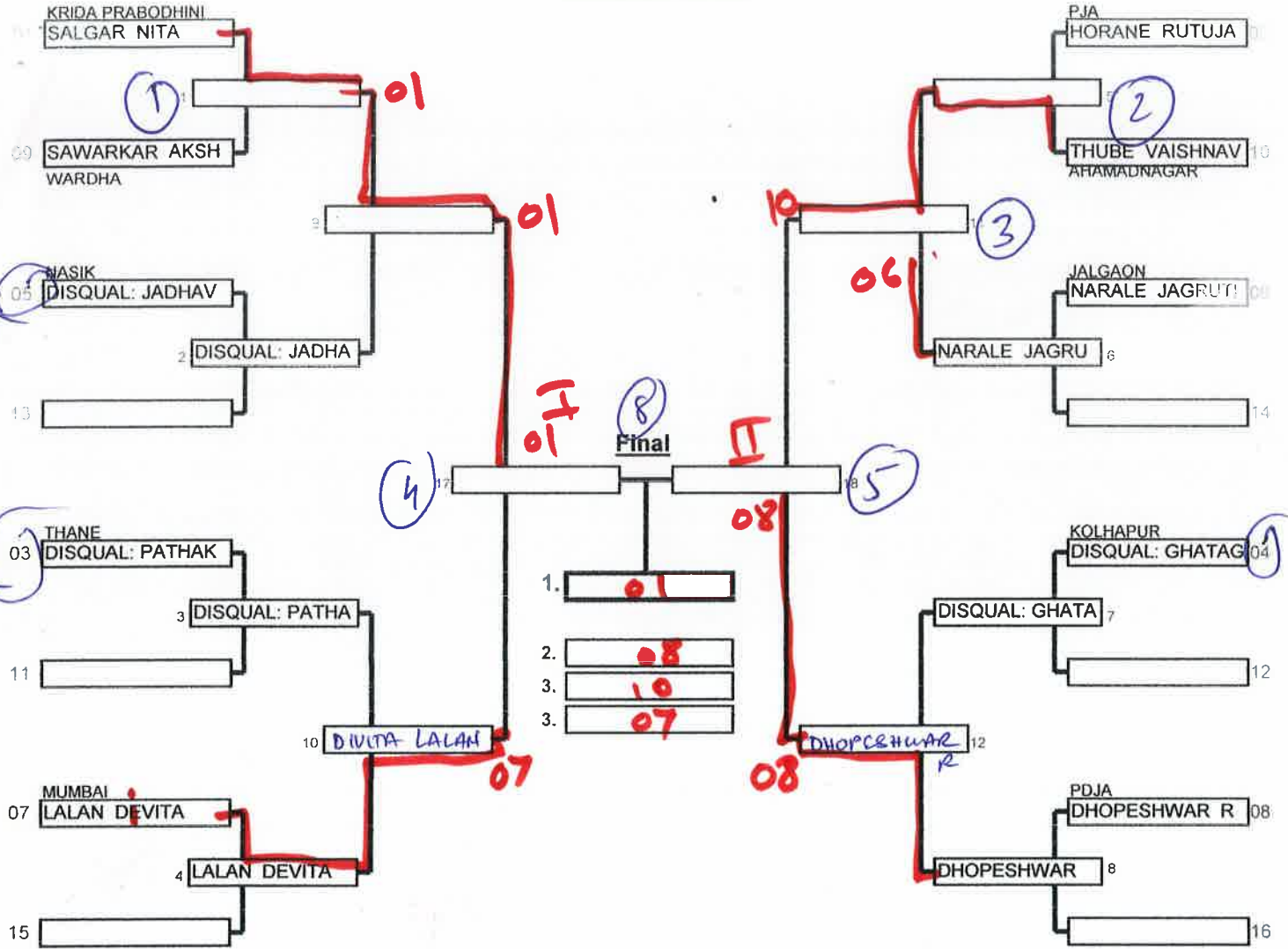

Repechage

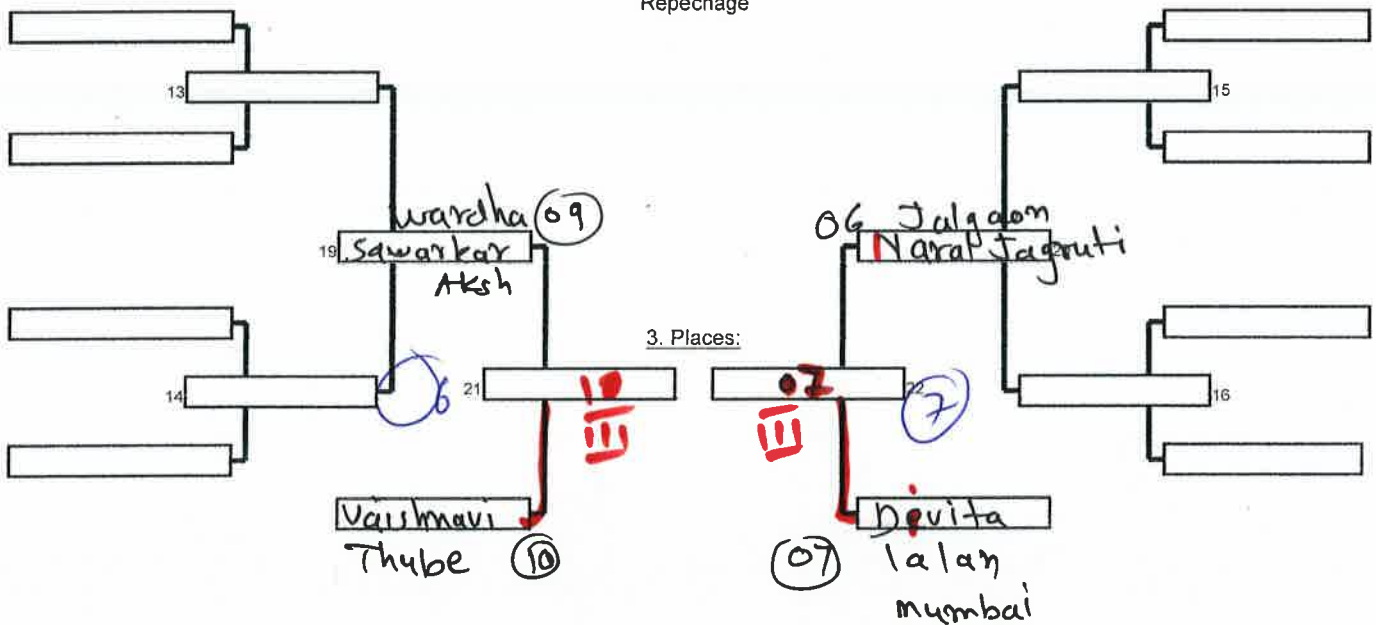

MAT-7

(MB)

X

Handwritten signature



MAR-3

M/B

**Poolk.**

Nr.	Name	Club	01	02	03	04	05	Wins / Pts	Weight	Place
01	BANSODE PRANJAL	SANGALI		0	0	0	0	0 0	kg	
02	PEDNEKAR UMA	AHAMADNAGAR	0		0	0	0	0 0	kg	
03	PATARPEKAR POOJA	MUMBAI	0	0		0	0	0 0	kg	
04	TAMBOLI TANVIN	KRIDA PRABODHINI	0	0	0		0	0 0	kg	
05	DHOPESHWAR POOJA	PDJA	0	0	0	0		0 0	kg	

**Matches:**

Round/Compe	Name ("blue")	Name ("white")	Winner	Pts.	Scores
1	04-05 TAMBOLI TANVIN	DHOPESHWAR PO	Tanvin - wazari - 3:30		
	01-02 BANSODE PRANJA	PEDNEKAR UMA	Uma Pedreka - Ippen - 1:00		
2	03-04 PATARPEKAR POO	TAMBOLI TANVIN	Tanvin - 3 Shido - 5:00		
	05-01 DHOPESHWAR PO	BANSODE PRANJA	Pooja walkover (CPB)		
3	02-03 PEDNEKAR UMA	PATARPEKAR POO	Pooja Pathepeka - wazari		
	04-01 TAMBOLI TANVIN	BANSODE PRANJA	Tanvin T - walkover (CPB)		
4	03-05 PATARPEKAR POO	DHOPESHWAR PO	Pooja Phatepeka - 1 Yuko & 2 Uta + 2:30		
	02-04 PEDNEKAR UMA	TAMBOLI TANVIN	Tanvin Tamboli - Ippen + 2:30		
5	01-03 BANSODE PRANJA	PATARPEKAR POO	Pooja P (walkover - PB)		
	05-02 DHOPESHWAR PO	PEDNEKAR UMA	Pooja Dhopeswar - Hold (2:39)		

winners

- I — Tanvin Tamboli - KP
- II — Pooja Phatepeka - Mumbai
- III — Pooja Dhopeswar - POJA
- IV — Uma Pedreka - Ahmednagar

*[Handwritten signature]*

*[Handwritten signature]*

MAT-3

M13

Preliminaries and final

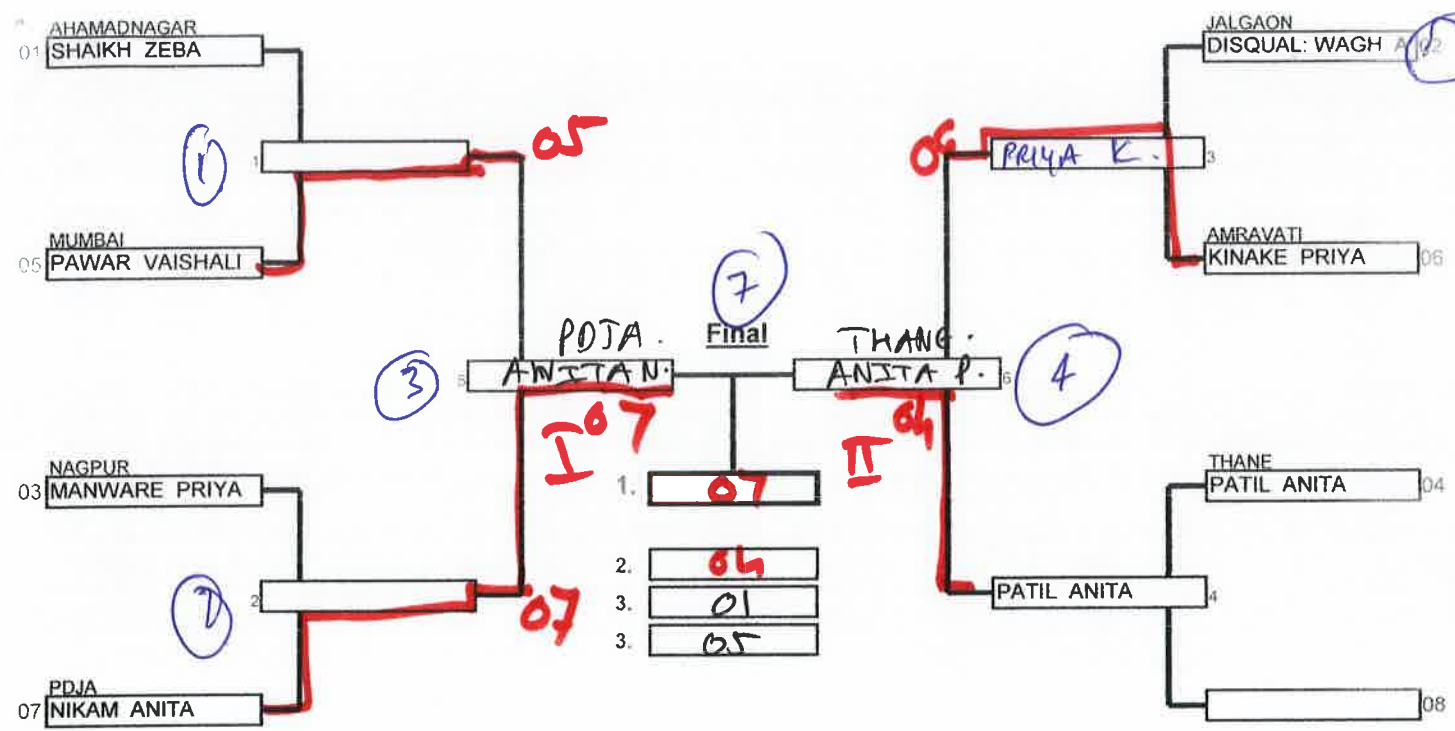

Repechage

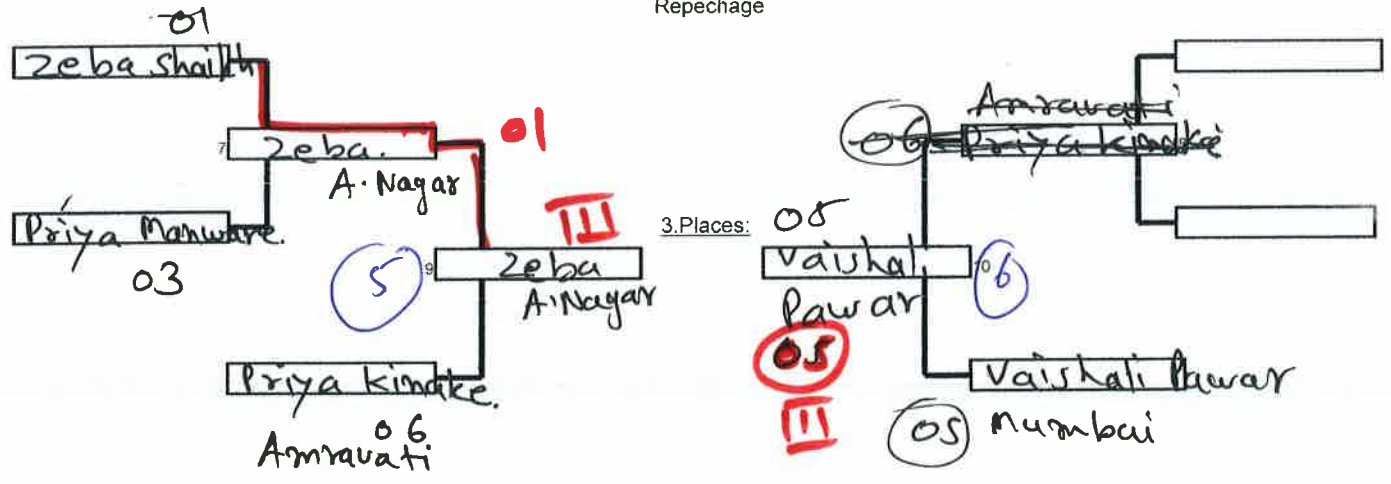

Handwritten signature and date: 11/02/2017