

ok

45TH CADET AND JUNIOR STATE CHAMPIONSHIP 2017-18, NASHIK

MAT NO. 2

DATE: 16/12/2017

Cadet Boys

wt. Category	Age Group	Name Of the Player	District	Rank
-45 kg	Cadet			
	25/6/2001	ASAY KADU	PUSA	GOLD
	30/10/2001	ROHIT CHAUDHARI CHAUDHARI	DHULE	SILVER
	19/10/2001	HARITHIK PANDEY	THANE	BRONZE
	21/8/2001	OSAMA KHAN	AURANGABAD	BRONZE

13

61

121

122

wt. Category	Age Group	Name Of the Player	District	Rank
-50 kg	CADET	PRATEK PATIL	KS	
	26/5/2000	PRATEK PATIL	KOLHAPUR	GOLD
	07/07/2001	ROHIT BHADAGE	DHULE	SILVER
	12/3/2001	ABHISHEK PATTAN PATTANSHETTI	SANGLI	BRONZE
	12/8/2001	SATISH WARAGNE	AURANGABAD	BRONZE

14

64

125

126

wt. Category	Age Group	Name Of the Player	District	Rank
-55 kg	CADET			
	20/3/2000	OMKAR DESAI	AURANGABAD	GOLD
	01/8/2001	PRATEK GUGHE	NASHIK	SILVER
	01/01/2002	PRATHAM GURAV GURAV	MUMBAI	BRONZE
	4/1/2001	DIYAKAR SONMALI SONMALI	PUSA	BRONZE

15

63

127

128

P. Babar
16/12/17

MAT CHAIRMAN

T. B. Patil
16/12/17

TOURNAMENT DIRECTOR

AD Sakpal
PUSA

Checked OK judo

Preliminaries and final

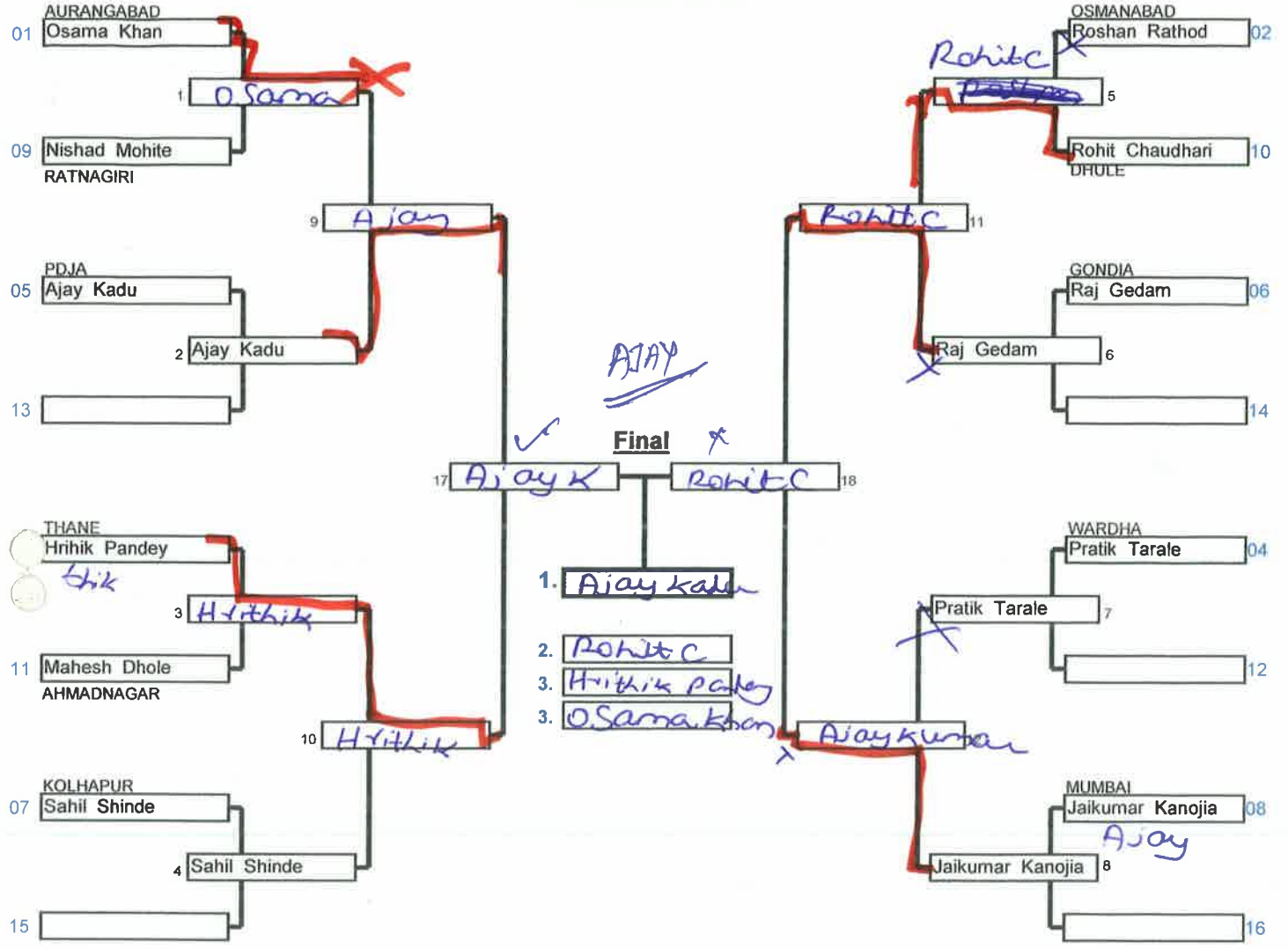

Repechage



JUDO Turnier Manager, Version 4.28 ; This copy only to be used by 'Österreichischer Judoverband' ! (= License owner)

 (c) franz.filzmoser@utanet.at Download Demo-Version: www.home pages.at/judo

 B Patil 16/12/17

 AD Sakpal PJA

Preliminaries and final

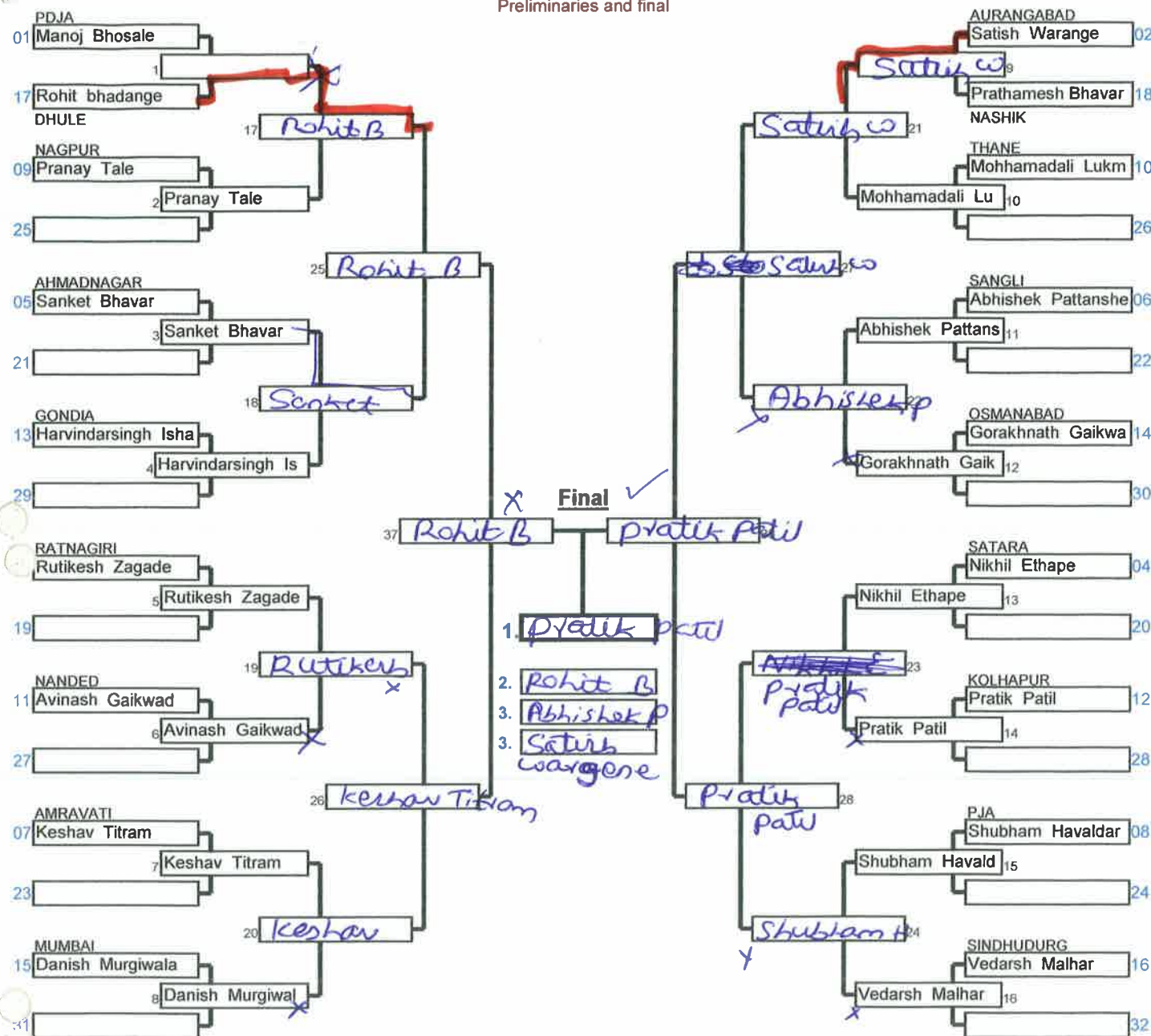

Repechage

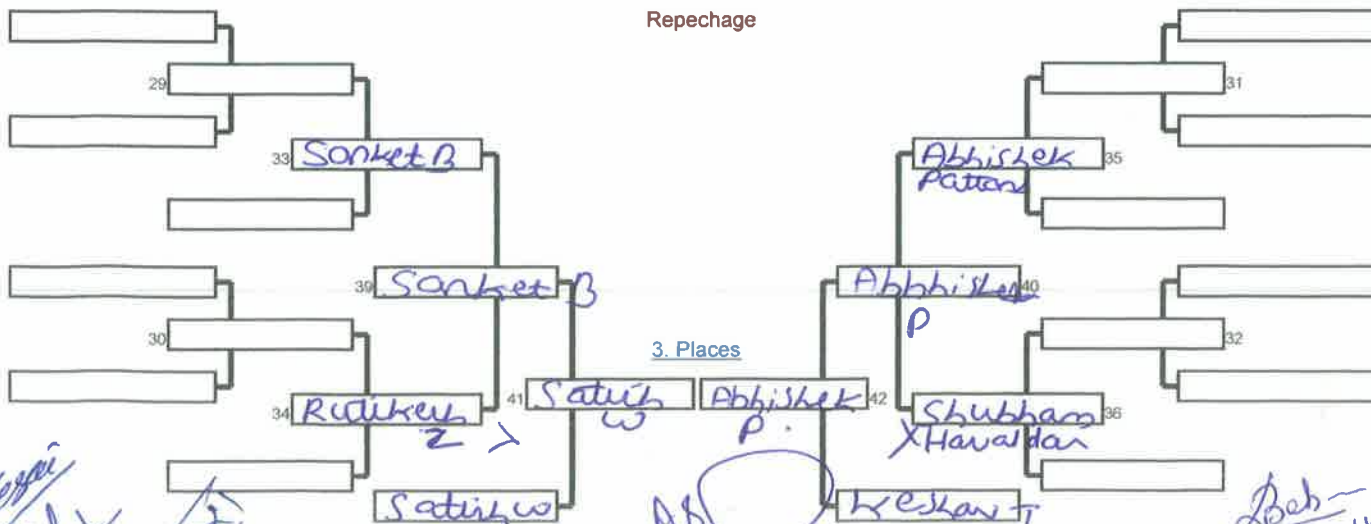

Handwritten notes:
 AD Sakpal PJA
 B. Patil
 16/12/17
 10

Preliminaries and final

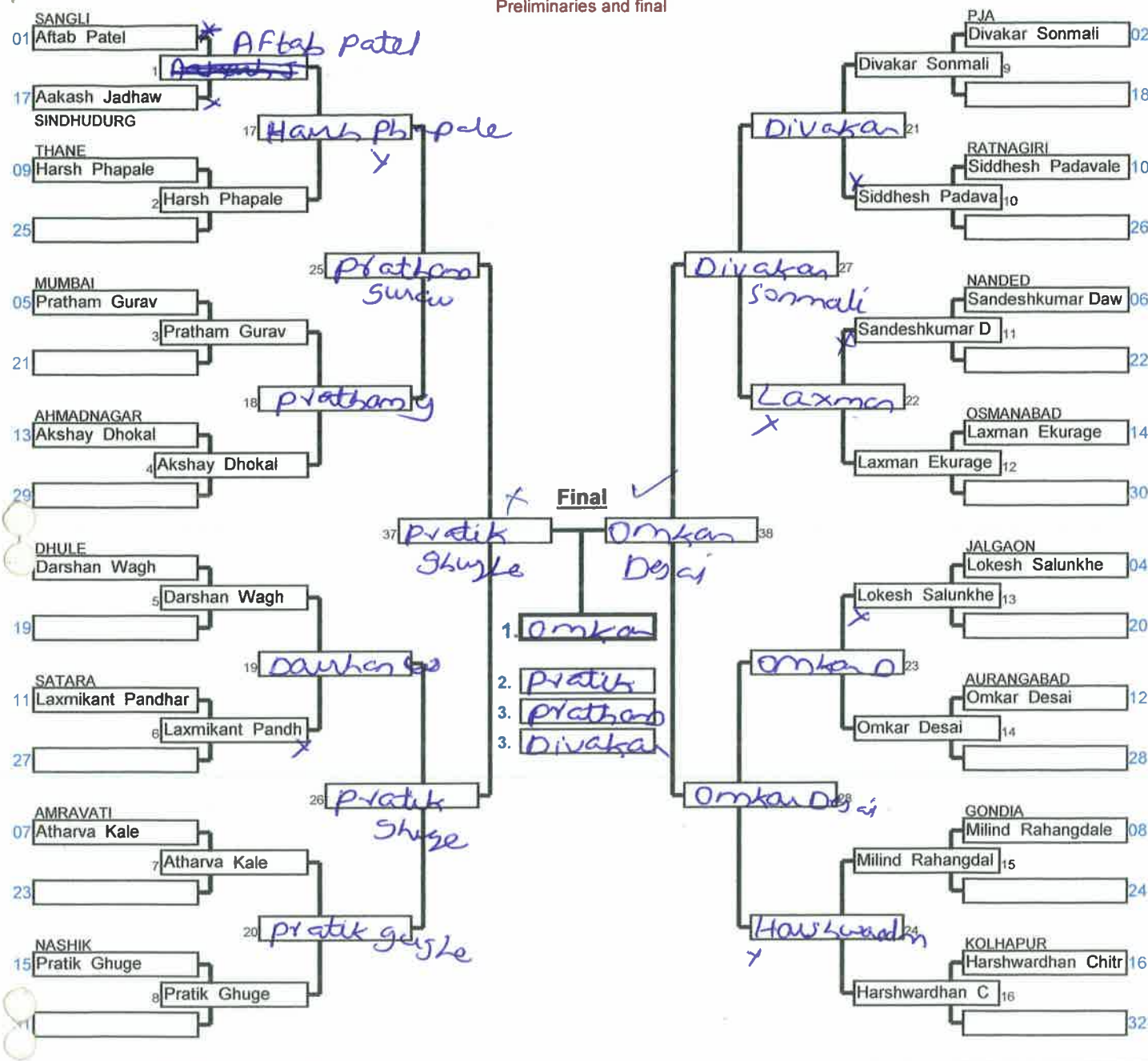

Repechage

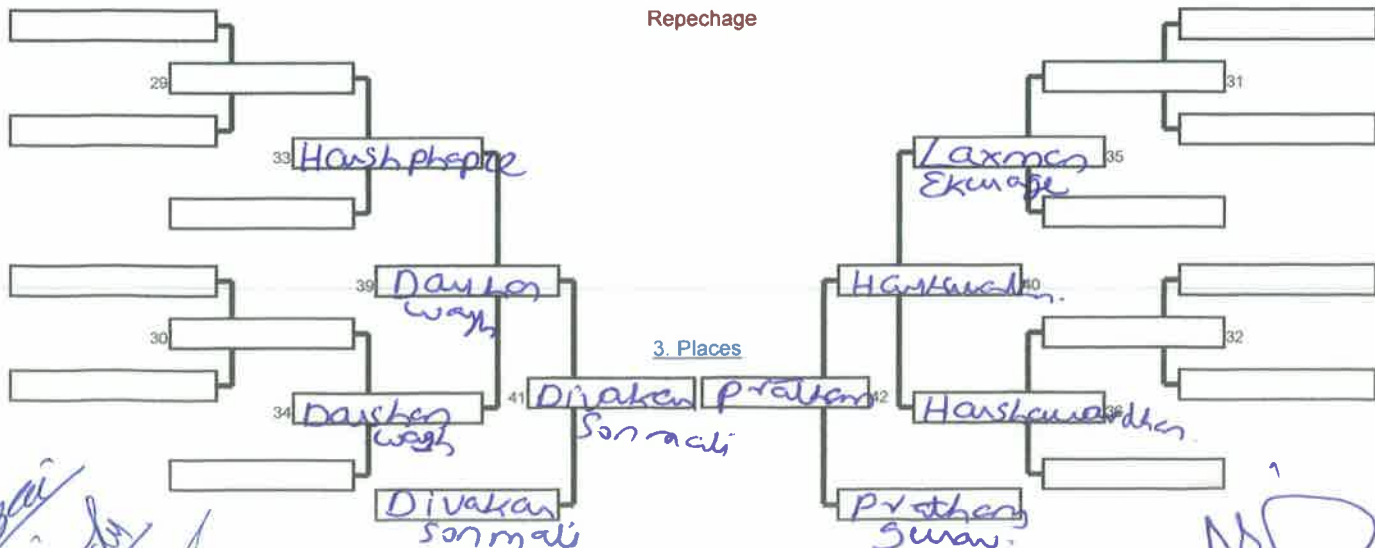

Handwritten signatures and notes at the bottom of the page, including 'A. Sakpal', 'Babbar', and 'Pratik' with dates '16/12/17' and '10/12/17'.

OK

45th Cadet and Junior State Championship 2017-18, Nashik

MAT NO. 2

DATE: 16-Dec-2017

wt. Category	Age Group	Name of the Player	Rank
5/5/2000	-60kg	CADET Boys	
22/1/2000	MUMBAI	ISHAN KANOJIYA	GOLD 34
4/5/2002	NASHIK	JAYESH SHETE	SILVER 62
21/2/2001	AURANGABAD	RITESH LIMAN	BRONZE 133
6/5/2000	PJA	AMAR BORATE	BRONZE 134

selected for nationals

wt. Category	Age Group	Name of the Player	Rank
	-66kg	CADET Boys	
9/5/2000	MUMBAI	GANESH SWAR	GOLD 32
25/7/2000	AHMEDNDR	ROHIT SHINDE	SILVER 70
28/6/2000	WARDHA	NAKUL AMBARKAR	BRONZE 139
23/8/2000	PJA	AJAY M HETRE	BRONZE 140

selected for nationals

wt. Category	Age Group	Name of the Player	Rank
	-73kg	CADET Boys	
18/3/2002	AHMEDNDR	ADITYA DHOAPAWAR	GOLD 33
25/3/2000	KOLHAPUR	PARTH PATIL	SILVER 76
10/2/2001	SONDHA	MEET PATEL	BRONZE 143
4/11/2000	YAVATMAL	AKID MALNAS	BRONZE 144

wt. Category	Age Group	Name of the Player	Rank
	-81kg	CADET Boys	
31/5/2001	AURANGABAD	FARZAD SHAIKH	GOLD 39
17/4/2002	MUMBAI	LUKMAN TAYEBALI	SILVER 41
8/8/2000	PJA	RANJEET SHRIRAM	BRONZE 83
5/3/2001	AHMEDNDR	SURAJ PANCHSOUKH	BRONZE 84
13/05/2001	(SANGLI)	PRANAV PATIL	151

AD

AD Selval
PJA

Babu
16/12/17

W Patil
16/12/17
TW

MD

Max - 2

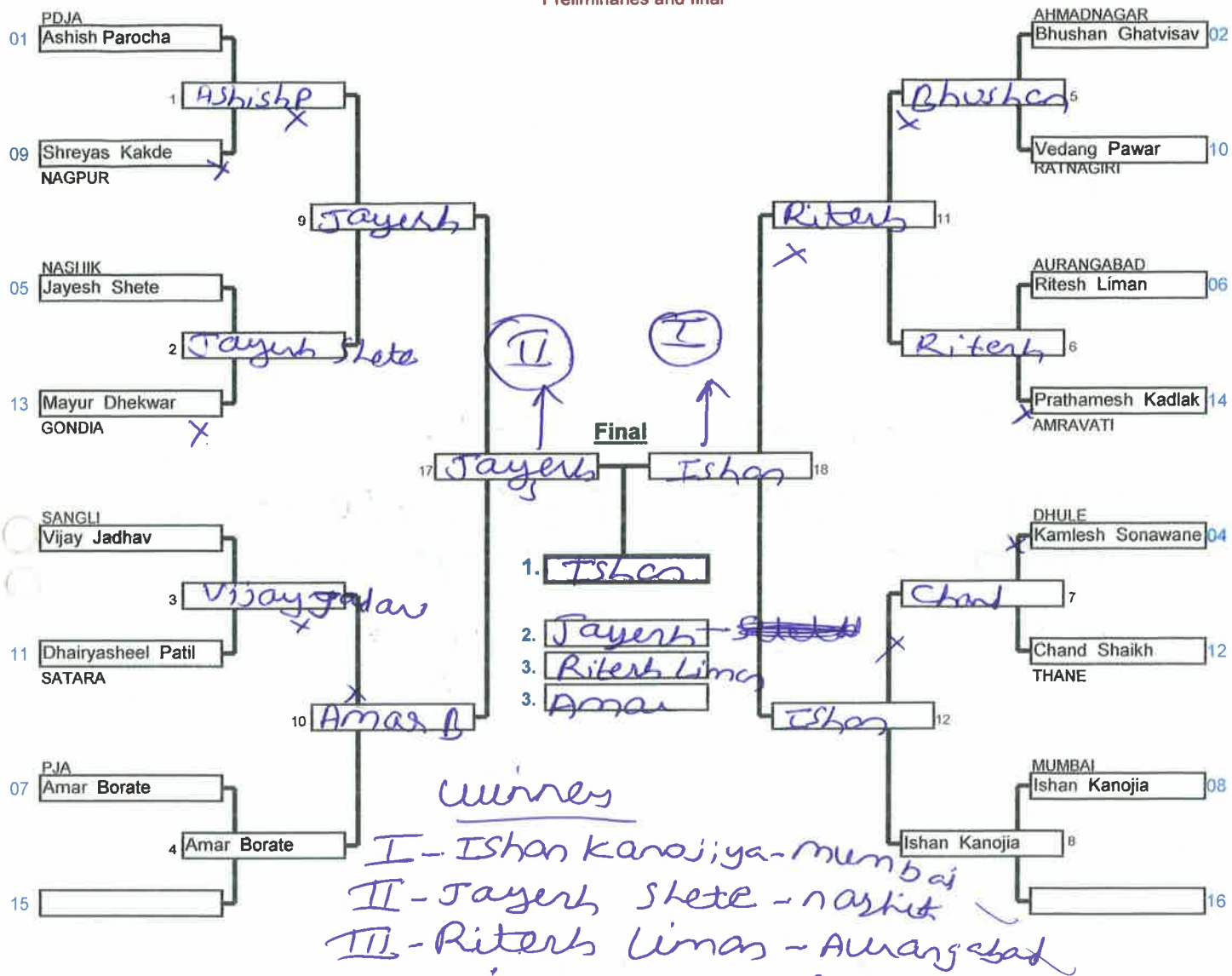

Preliminaries and final

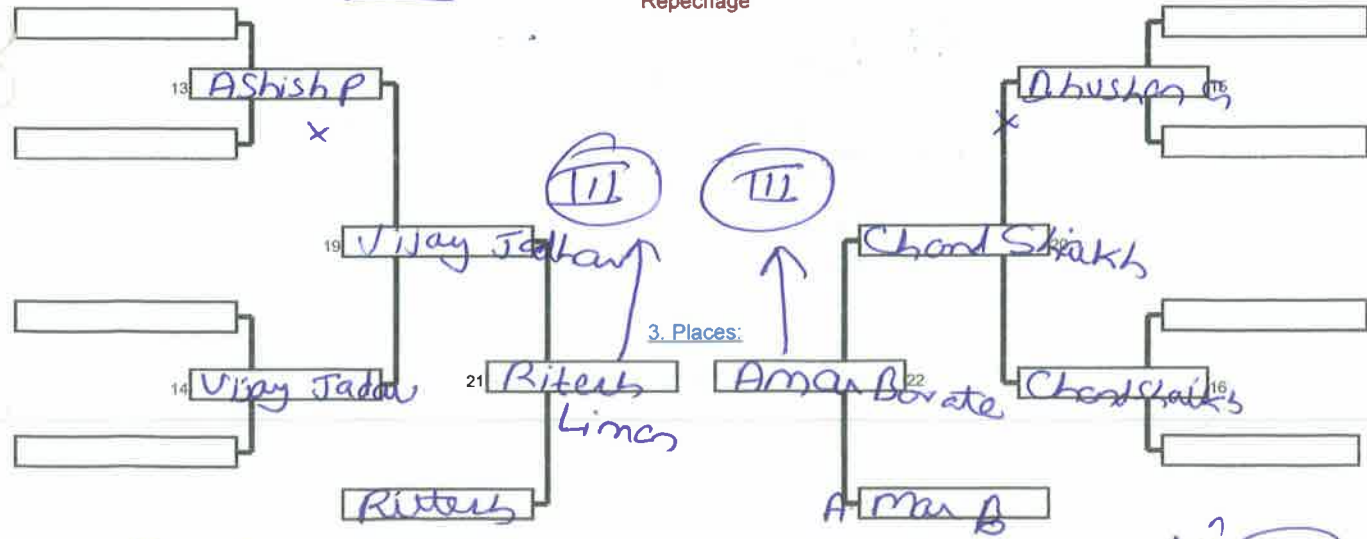

Winners
 I - Ishan Kanojia - Mumbai
 II - Jayesh Shete - Nashik
 III - Ritesh Liman - Aurangabad
 IIII - Amar Borate - PJA

Repechage

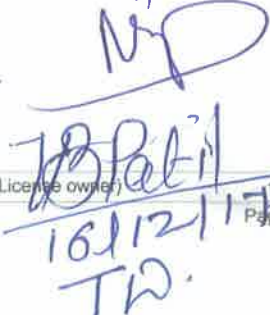

 Babu 16/12/17
 Shinde
 Joshi
 Patil 16/12/17 TW.

Mat - 2

Preliminaries and final

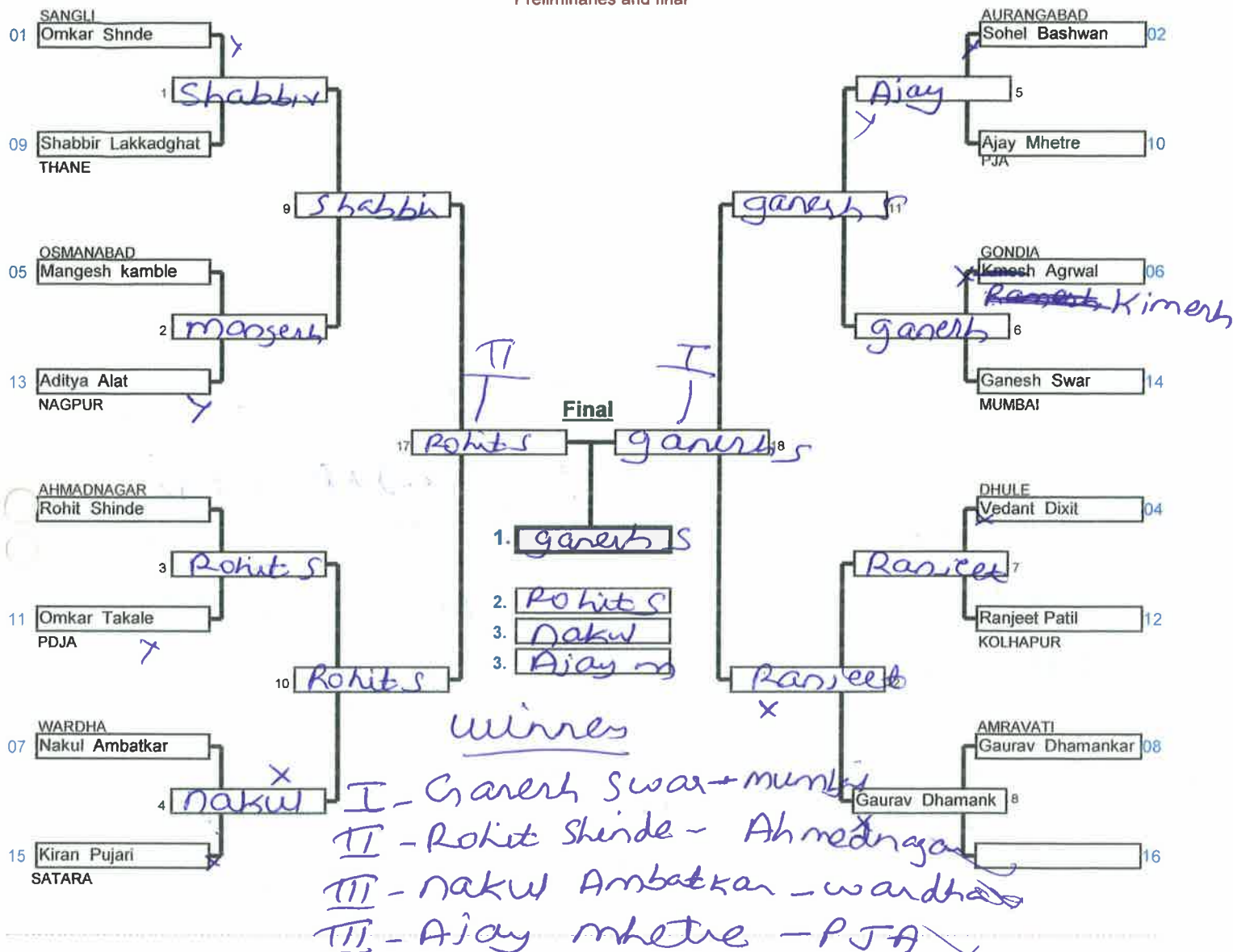

Repechage

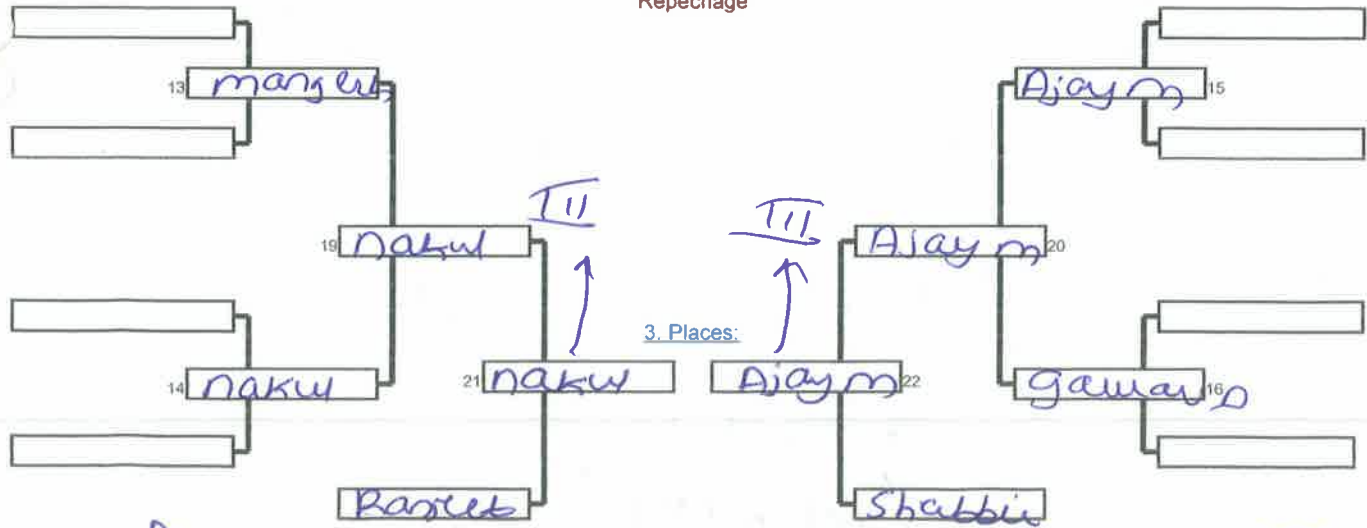

(Handwritten signatures and notes)

Rebar 15/12/17

Shinck

Pegai

AD Sakral PJA

Mat. 2

Preliminaries and final

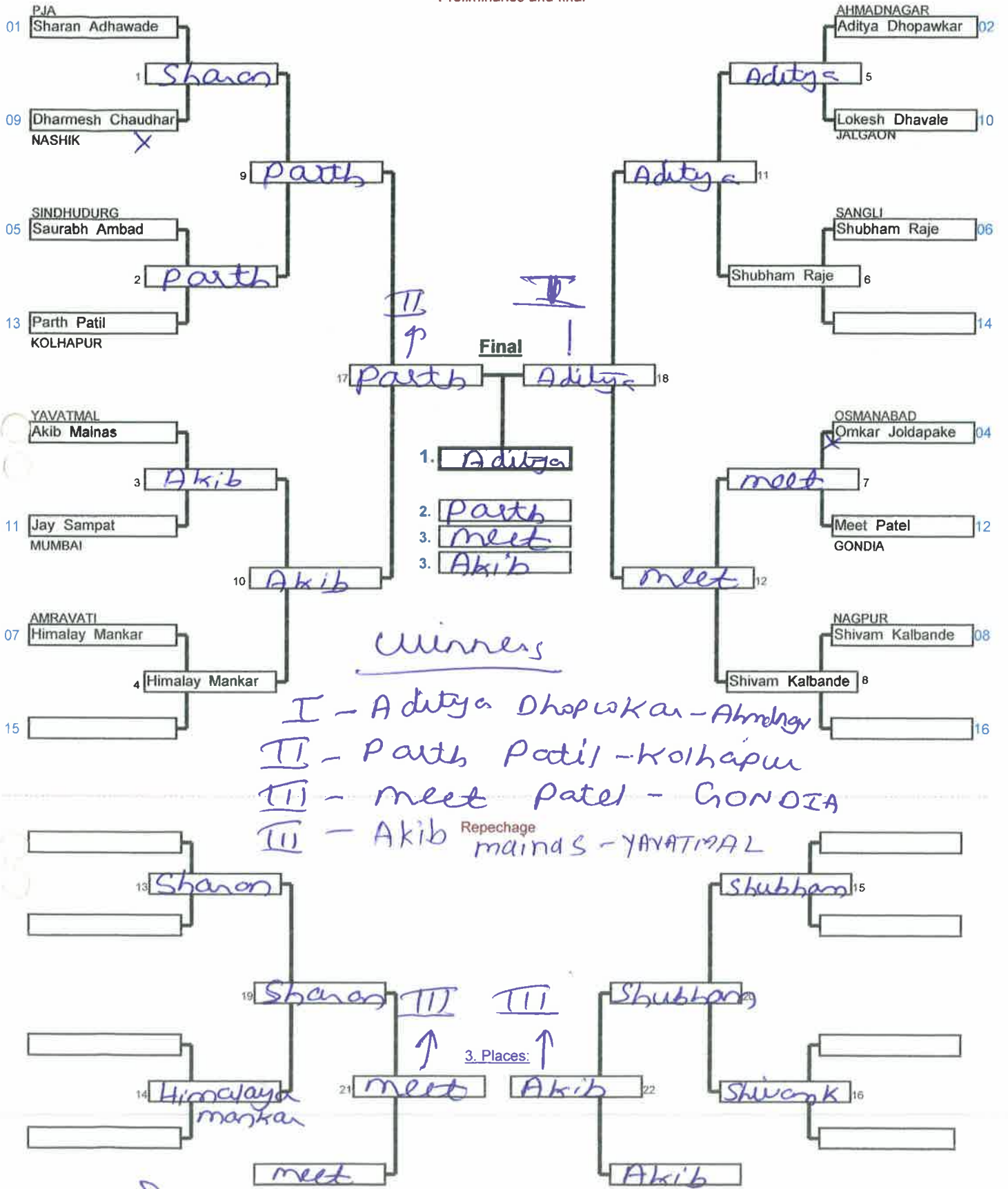

[Handwritten signatures and dates]

15/12/17

Shubh

MD

Preliminaries and final

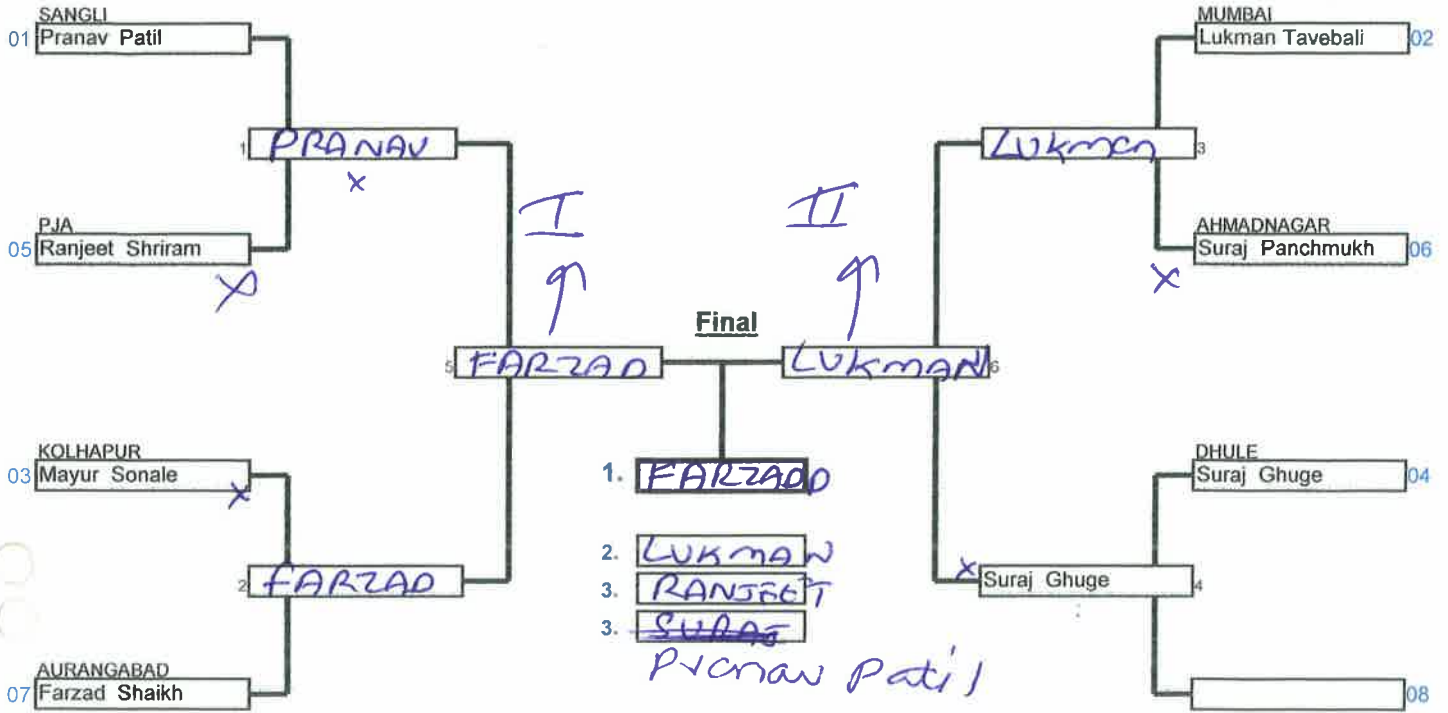

Repechage

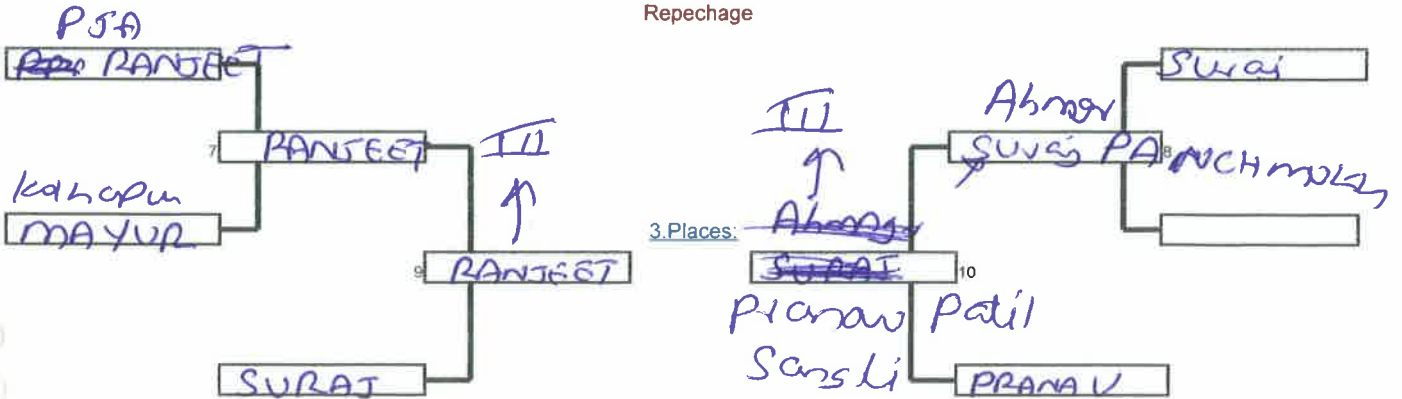

FINAL RESULT

OK

45TH CADET AND JUNIOR STATE CHAMPIONSHIP 2017-18, NASHIK

MAT NO. 1

CADET GIRLS

DATE: 16-12-2017

Cadet Girls

wt. Category	Age Group	Name Of the Player	District	Rank
-36	Cadet			
-36	12/08/2002	Amruta Gupta	Thane	GOLD 37
-36	04/05/2002	Samruddhi Dandvate	Satara	SILVER 80
-36	10/11/2002	Shivani Warake	Kolhapur	BRONZE 159
-36	22/07/2002	Sumaiyya Sayed	PDJA	BRONZE 160

wt. Category	Age Group	Name Of the Player	District	Rank
-40	11/02/2001	Rohini Mohite	K.P.	GOLD 40
-40	21/11/2001	Kalyani Raut	Nagpur	SILVER 78
-40	09/01/2001	Aishwarya Shelke	Sangli	BRONZE 155
-40	18/6/2002	Vaishali Sahare	Nashik	BRONZE 158

wt. Category	Age Group	Name Of the Player	District	Rank
-44	10/10/2001	Rani Khomne	K.P.	GOLD 18
-44	11/02/2001	Ragini Mohite	Amaravati	SILVER 60
-44	28/01/2001	Devshnee Kumar	Nagpur	BRONZE 119
-44	01/06/2001	Pearl Shah	Mumbai	BRONZE 120

Signature
Santosh Kanare

Signature

MAT CHAIRMAN

NILESH SHELKE

Signature
(Amal Desai)

Signature
J-A Sakhare

Signature
A. S. Salgal
P. J. A.

Signature
D. Kashid

Signature
16/12/2017

TOURNAMENT DIRECTOR

V. B. Patil

Preliminaries and final

MT - 1

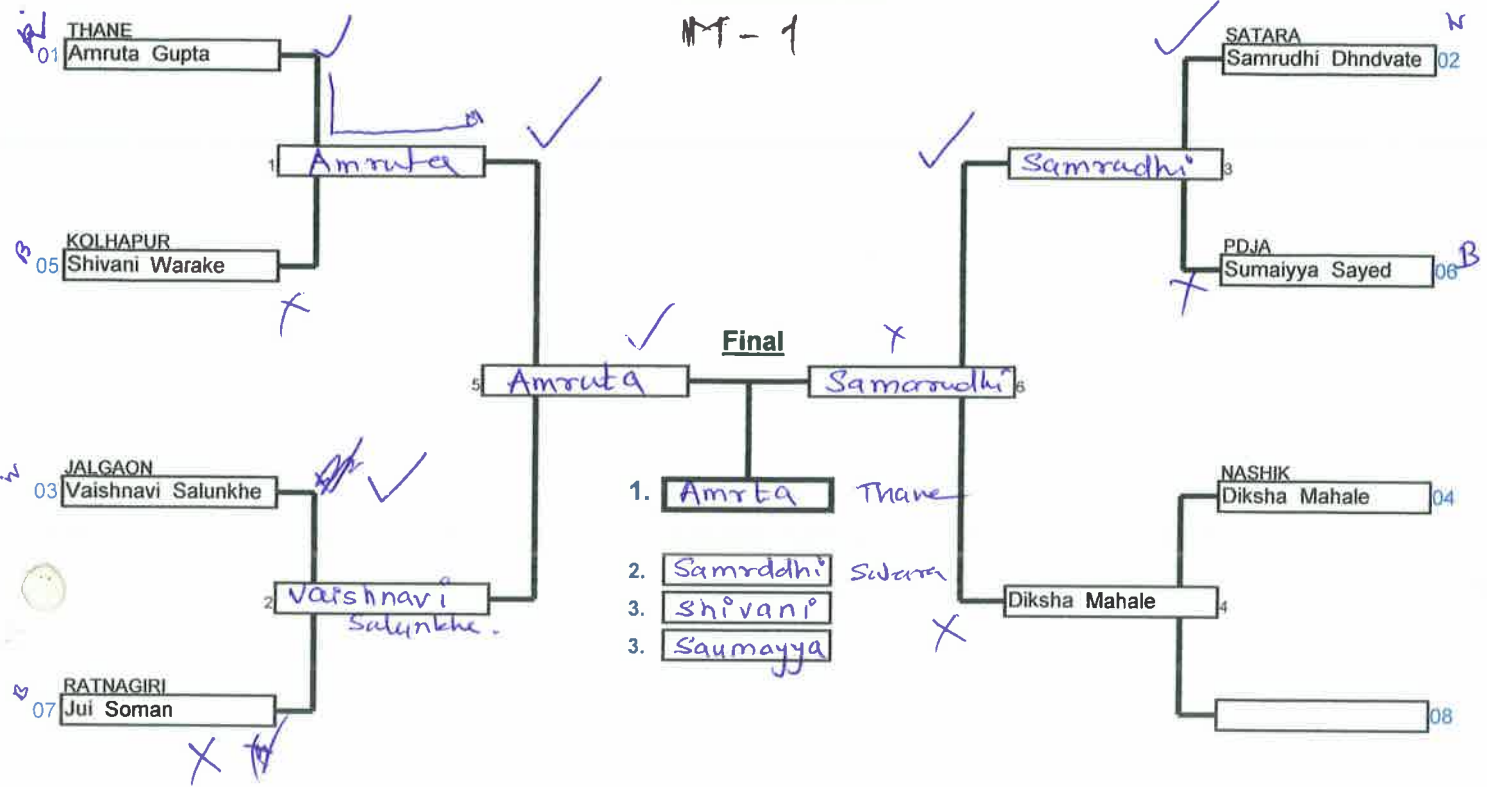

Repechage

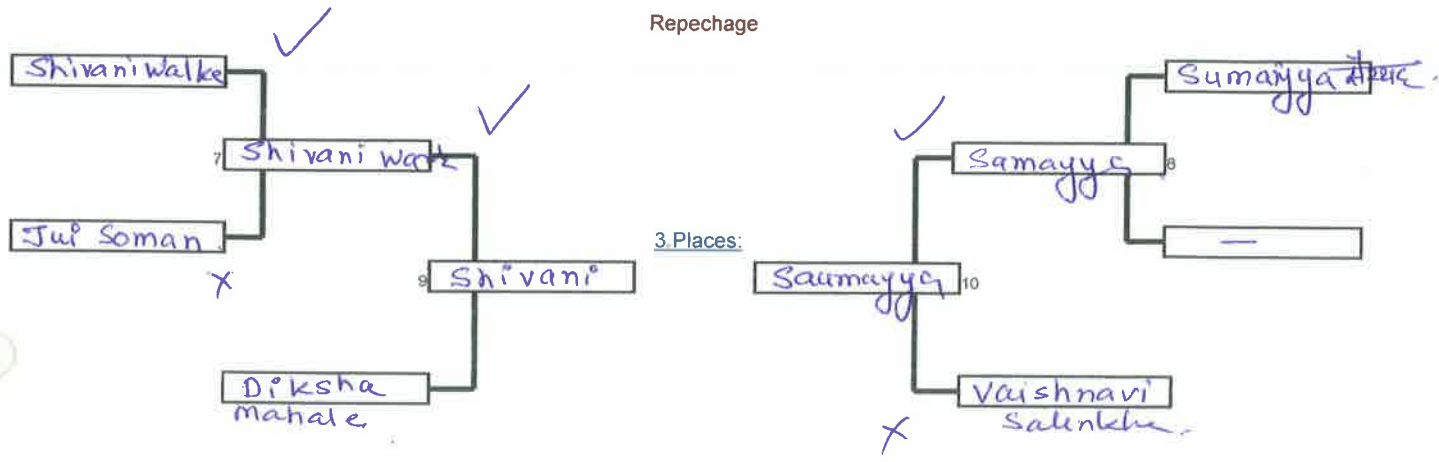

Handwritten signatures and notes:

Amul Desai
Diksha Mahale
AD Sakpal
PJA
Sumayya
16/12/17
TD

Preliminaries and final

M-1

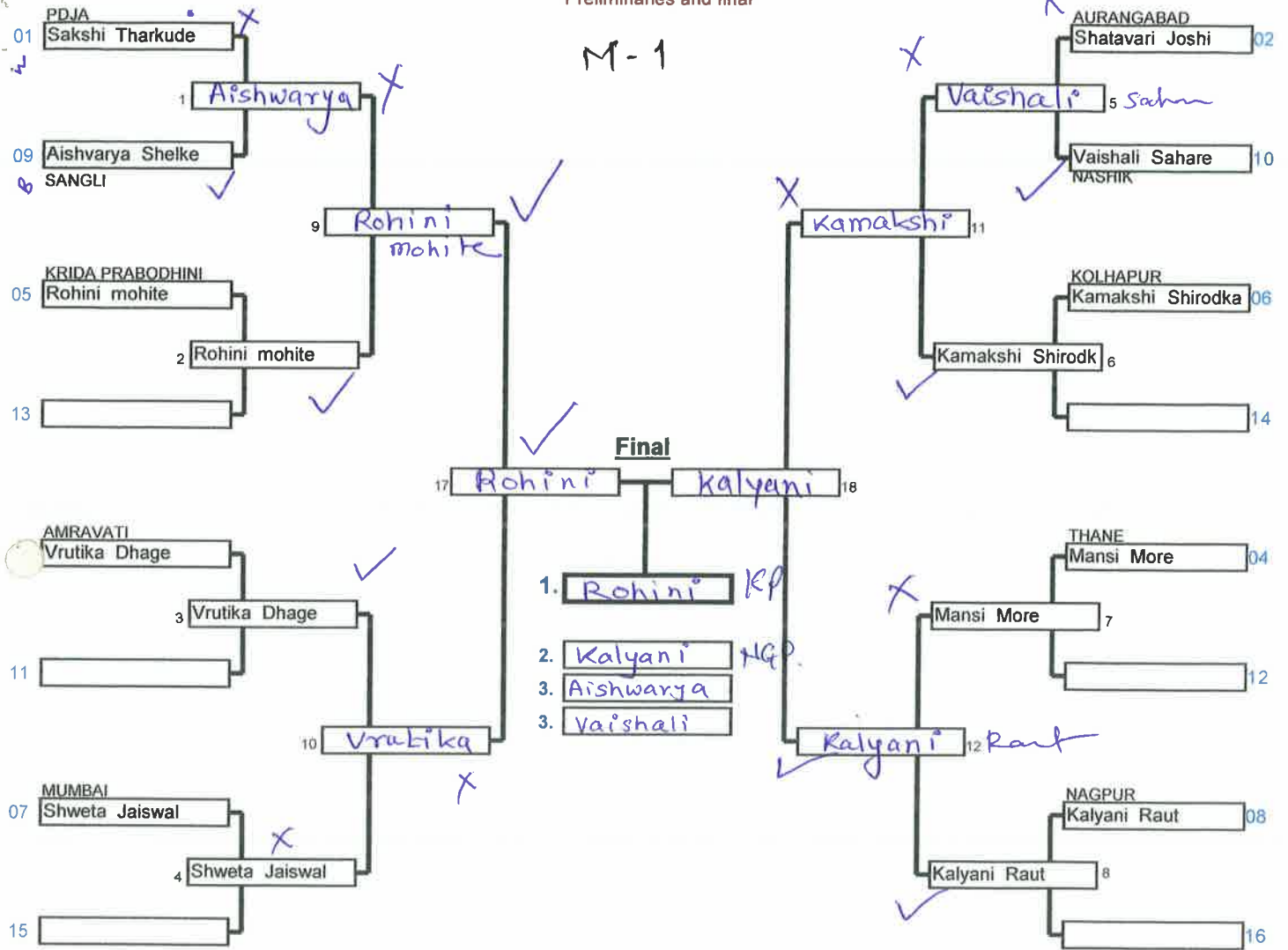

Repechage

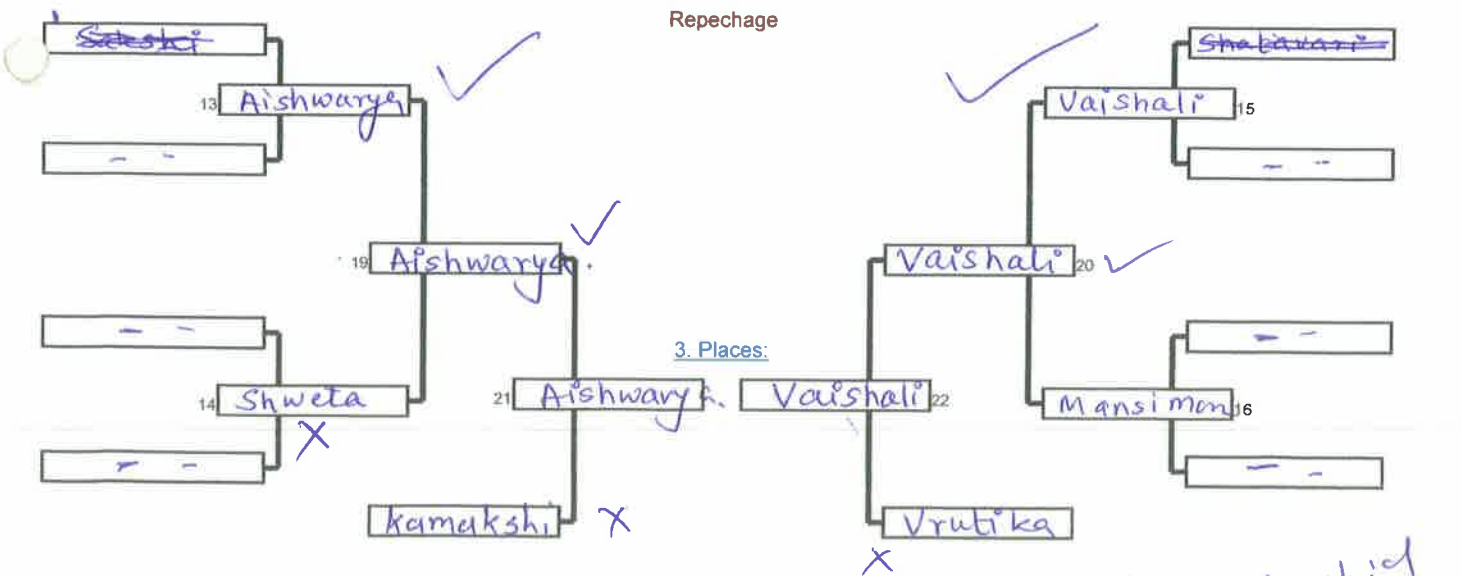

Amal Desai
 Sakshani
 Akashid
 AD Sakshani
 BOA
 18/12/17
 TZO

Preliminaries and final

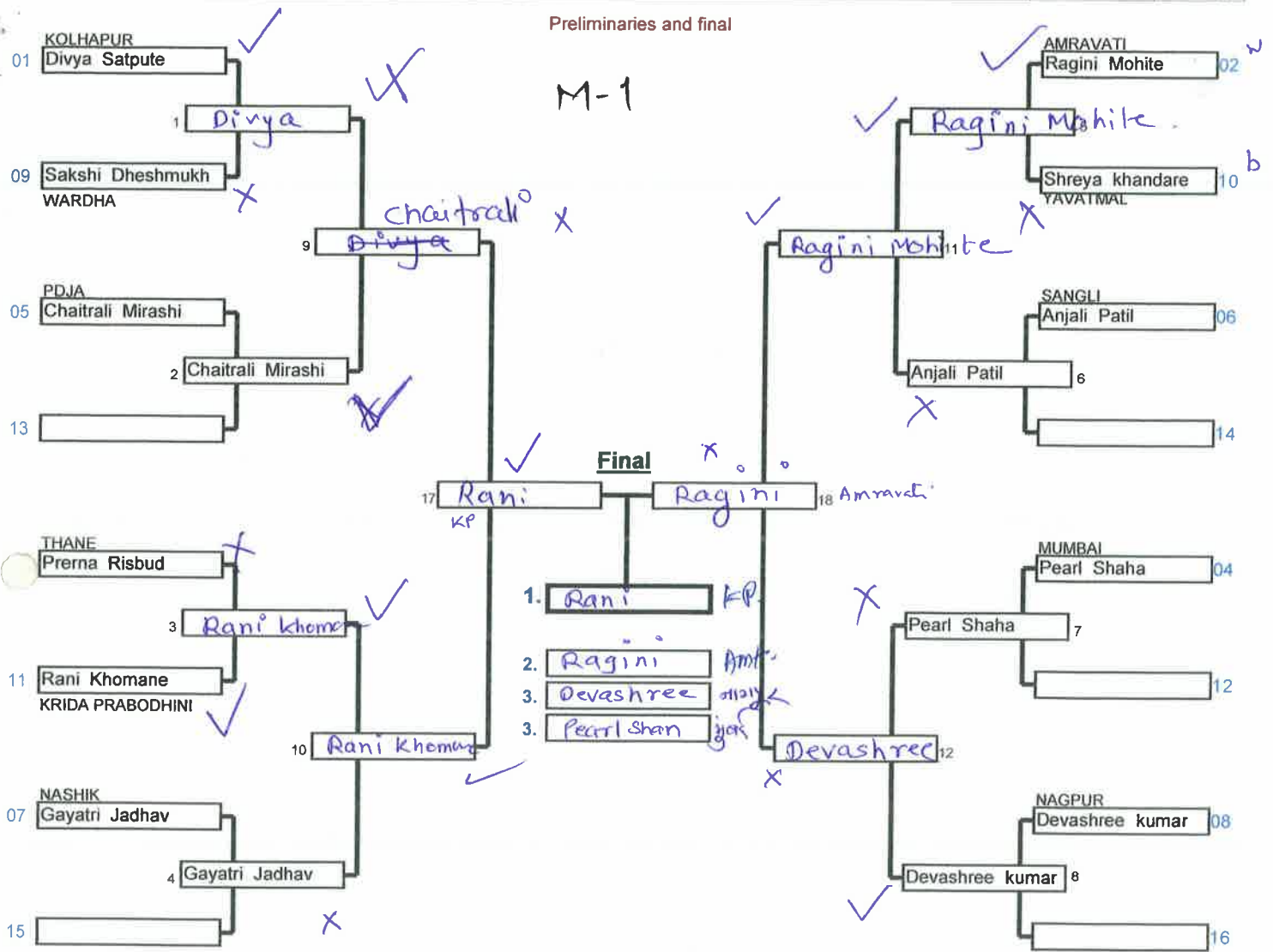

Repechage

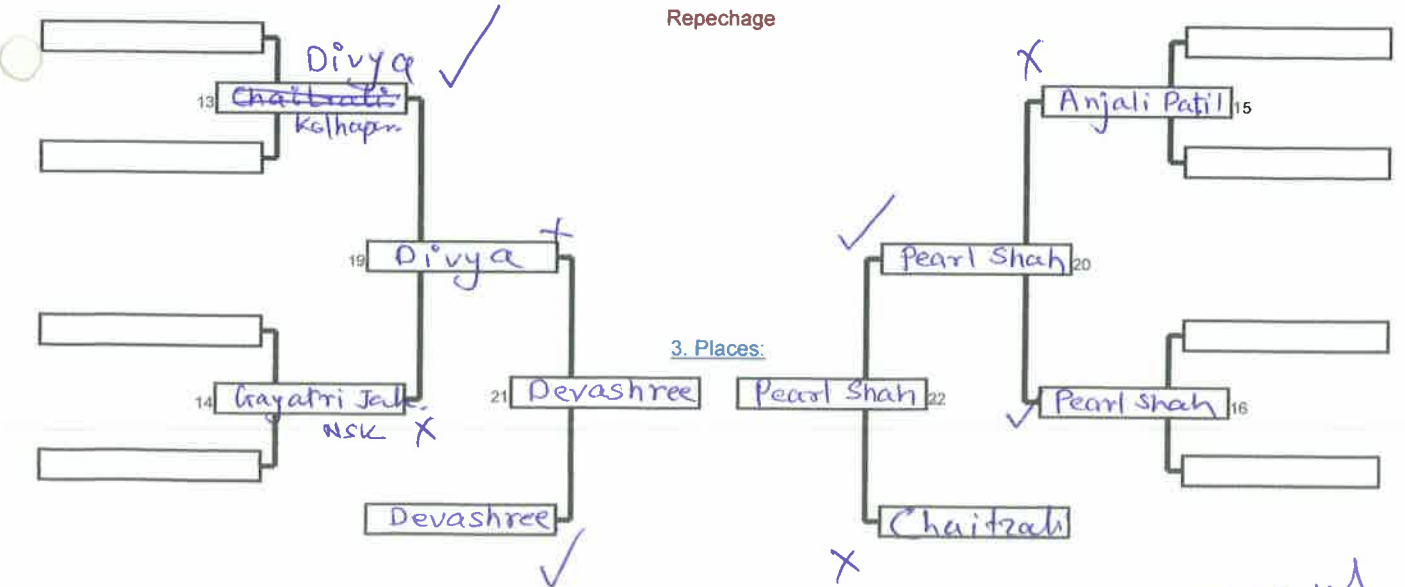

OK

45th Cadet and Junior State Championship 2017-18, Nashik

MAT NO. 1

DATE: 16-12-2017 - Cadet Girls

wt. Category	Age Group	Name of the Player	Rank
	Dist		
-48	K.P.	Mahima Gadilohar	GOLD
-48	Amaravati	Shweta More	SILVER
-48	Kolhapur	Siddhi Shiravadekar	BRONZE
-48	Sangali	Prajakta Patil prajakta	BRONZE

DOB

23/4/2002 19
 10/11/2002 69
 20/9/2001 137
 18/10/2000 138

wt. Category	Age Group	Name of the Player	Rank
-52	K.P.	^{सोनेची} Snehal Khavare	GOLD
-52	Kolhapur	Nupur Chavan	SILVER
-52	Amaravati	Priyanka Dongre ^{सोनेची}	BRONZE
-52	Aurangabad	Ashwini Sahane	BRONZE

20/7/2001 20
 1/3/2002 71
 12/2/2002 141
 5/2/2000 142

wt. Category	Age Group	Name of the Player	Rank
-57	Amaravati	Sapana Pande	GOLD
-57	Nasik	Pranali Lute	SILVER
-57	Mumbai	Saanvi Khot	BRONZE
-57	Aurangabad	Tejaswini Barwal	BRONZE

22/8/2000 21
 30/7/2000 73
 12/12/2002 145
 18/11/2000 146

wt. Category	Age Group	Name of the Player	Rank
-63	K.P.	Kajal Autade	GOLD
-63	Mumbai	Radhika Jethwa	SILVER
-63	Thane	Pranjal Puranik	BRONZE
-63	PJA	Tejashree Vyawahare तेजश्री	BRONZE

20 02/07/2000 30
 2/12/2002 62
 13/4/2001 123
 18/3/2001 124

-swath.kanare

~~Ande~~

AD Sakpal
PJA

JP Patil
10/12/2017
Tournament Director

Mat Chairman
(Nish Shelke)

MAT-1

Cadet Girls U/18	44 To 48 Kg girls	45th Cadet Girls and Boy	Meetai Thakare Stadi	15/12/2017	12 Cmp.
Elimination System with Double Repechage for 9 to 16 Competitors				4 min	Matte

Preliminaries and final

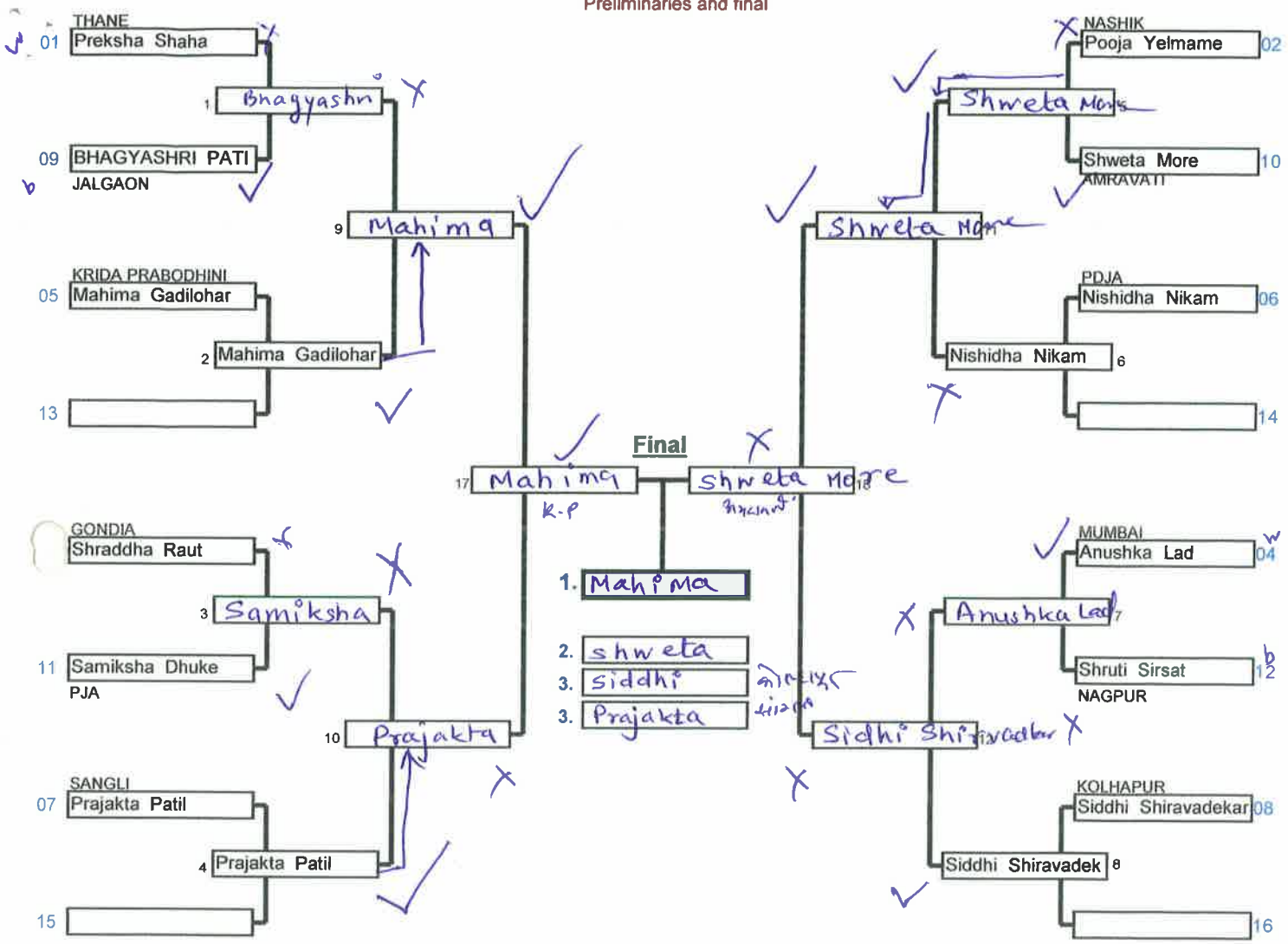

Repechage

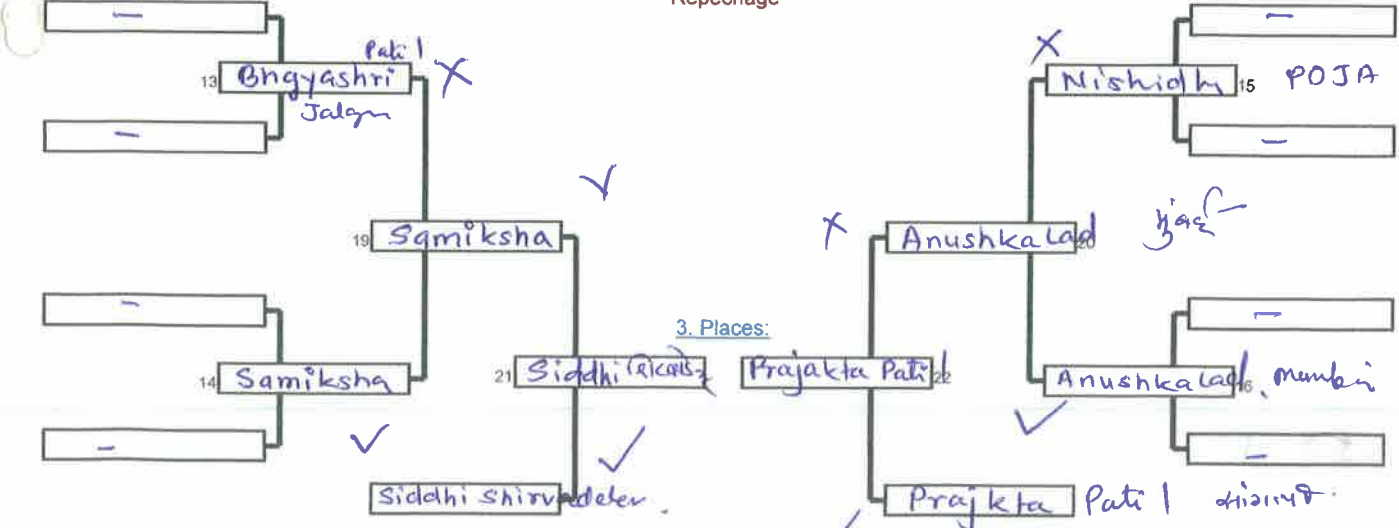

[Signature] Mitesh Shete
 [Signature] Madhusmi K. Jankar
 [Signature] J.A. Sakhare
 [Signature] Akhane
 [Signature] ADS Akpud & J.A.
 [Signature] B.P. Patil
 [Signature] T.L.D.

Mat - 1

Cadet Girls U/18	48 To 52 Kg girls	45th Cadet Girls and Boy	Meetai Thakare Stadi	15/12/2017	8 Cmp.
Elimination System with Double Repechage for up to 8 Competitors				4 min	Matte

Preliminaries and final

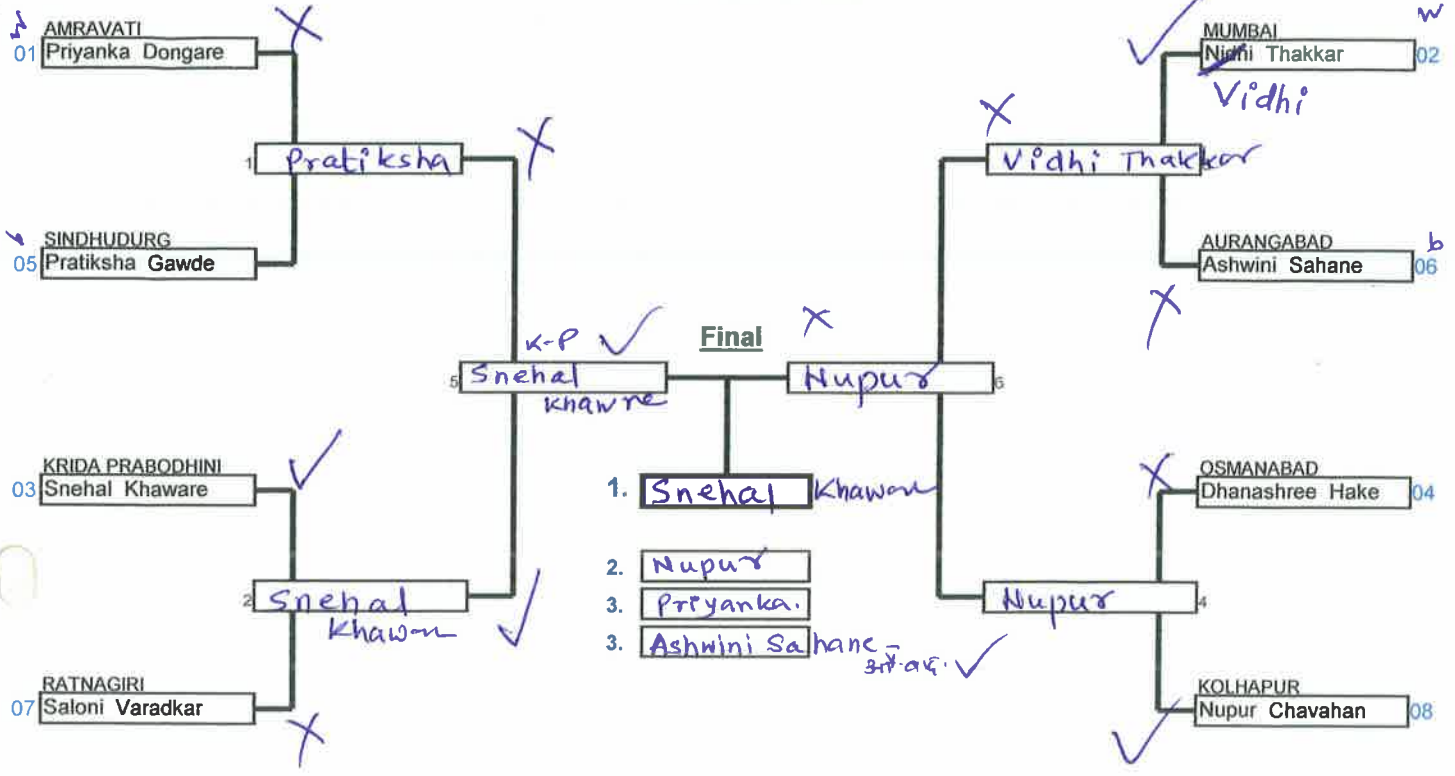

Repechage

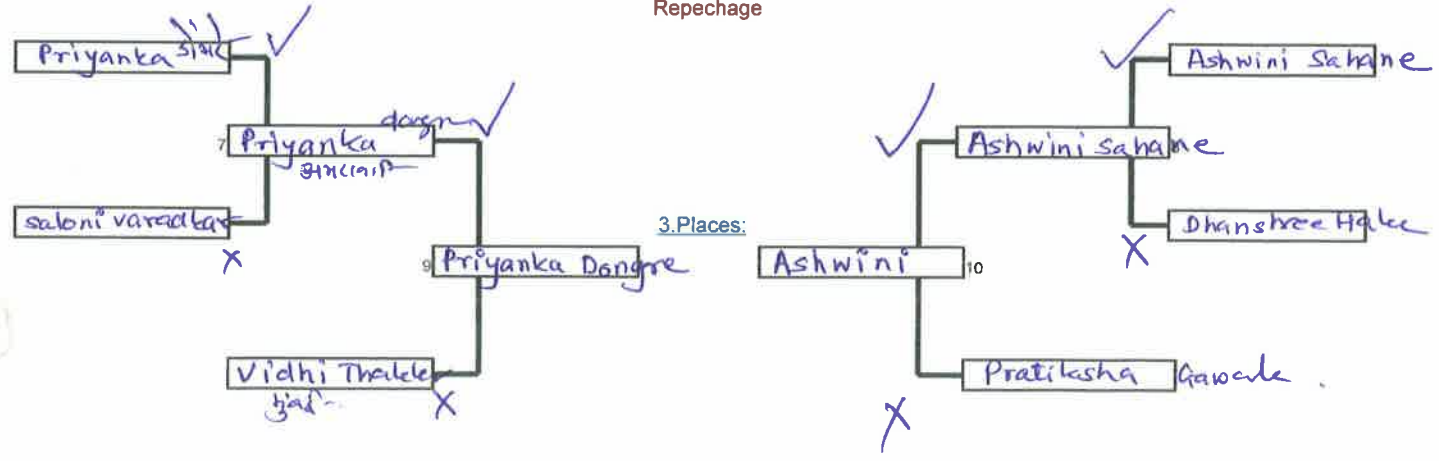

Nilosh Shelke

Madhusri K.

BPatil

ADSalgal

Skanane

Mat-1

Cadet Girls U/18	52 To 57 Kg girls	45th Cadet Girls and Boy	Meetai Thakare Stadi	15/12/2017	9	Cmp.
Elimination System with Double Repechage for 9 to 16 Competitors				4 min	Matte	

Preliminaries and final

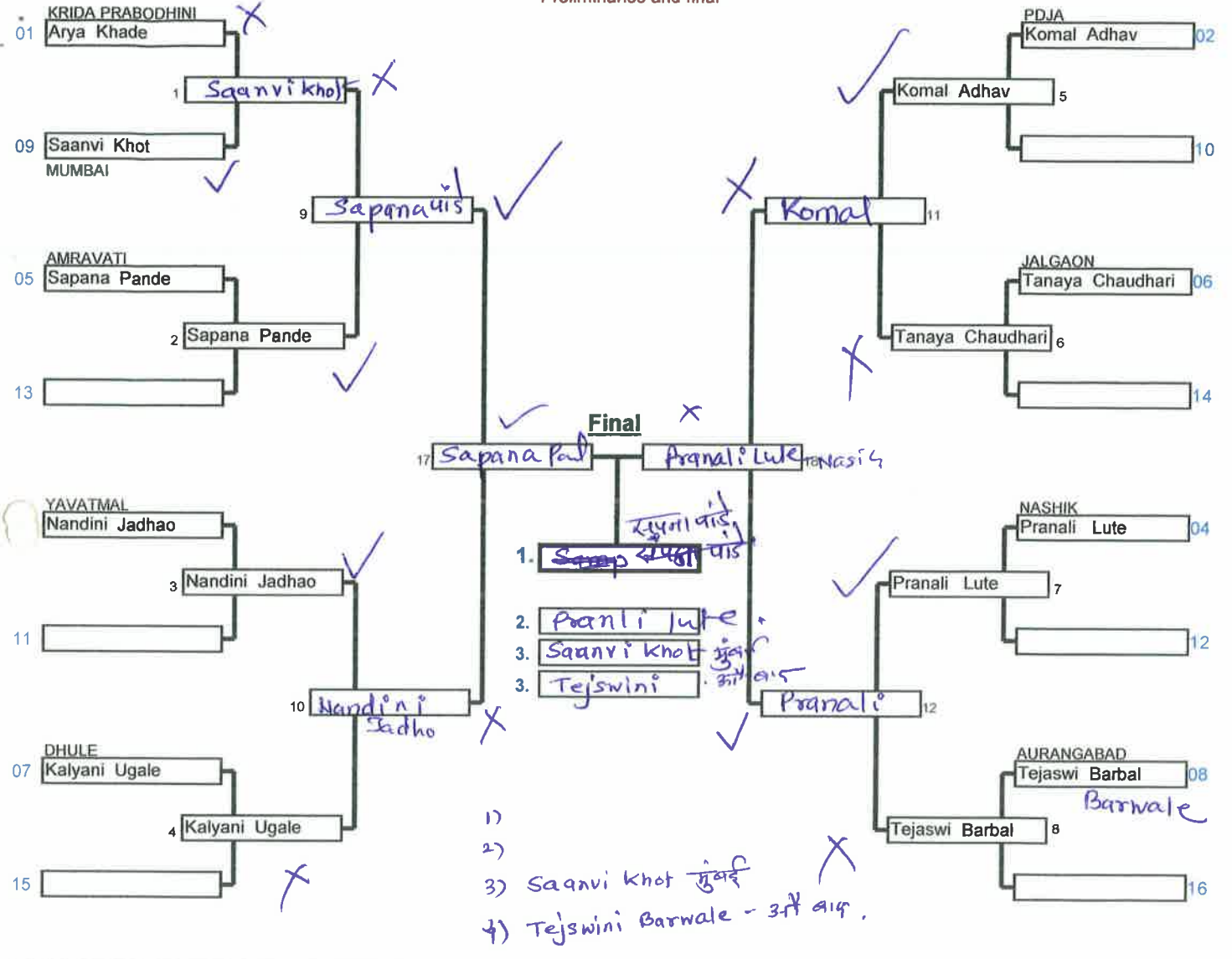

Repechage

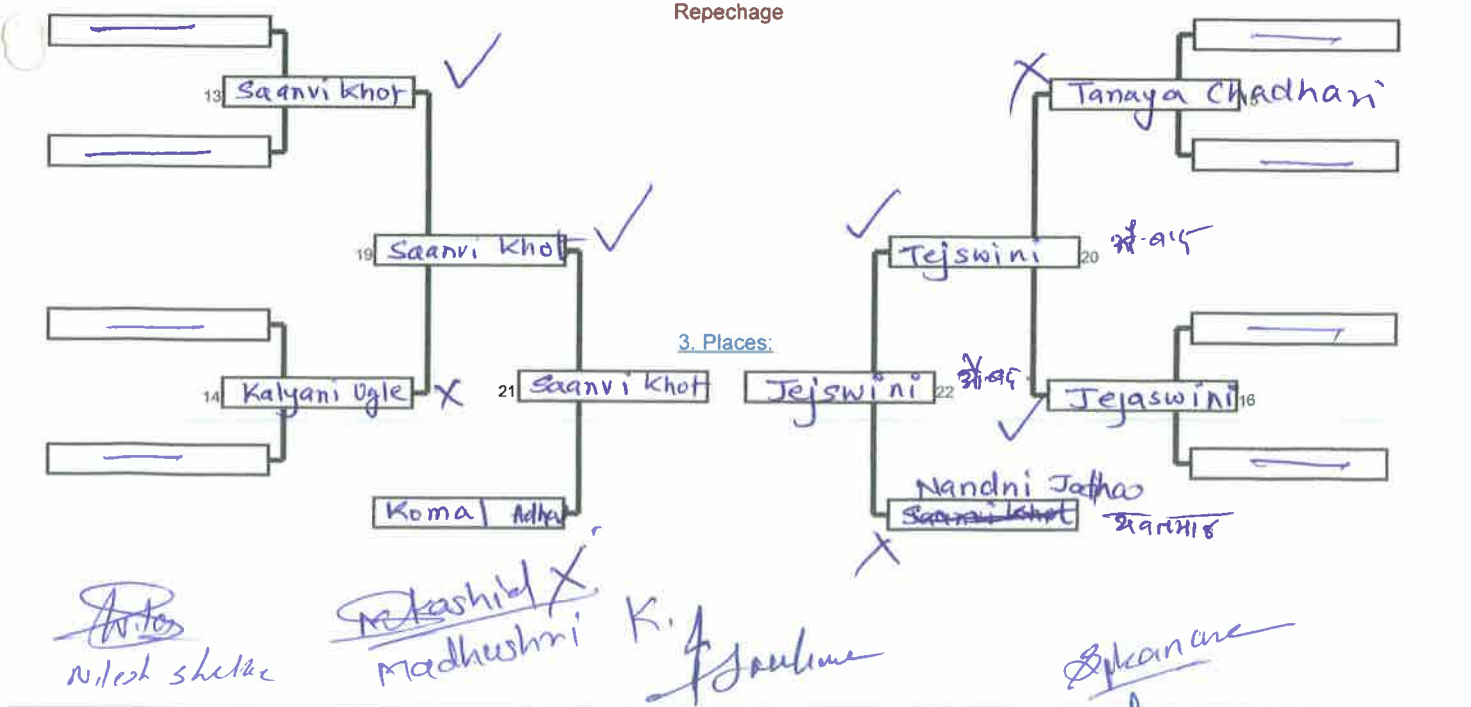

Mat-1

Cadet Girls U/18	57 To 63 Kg girls	45th Cadet Girls and Boy	Meetai Thakare Stadi	15/12/2017	8	Cmp.
Elimination System with Double Repechage for up to 8 Competitors				4 min	Matte _	

Preliminaries and final

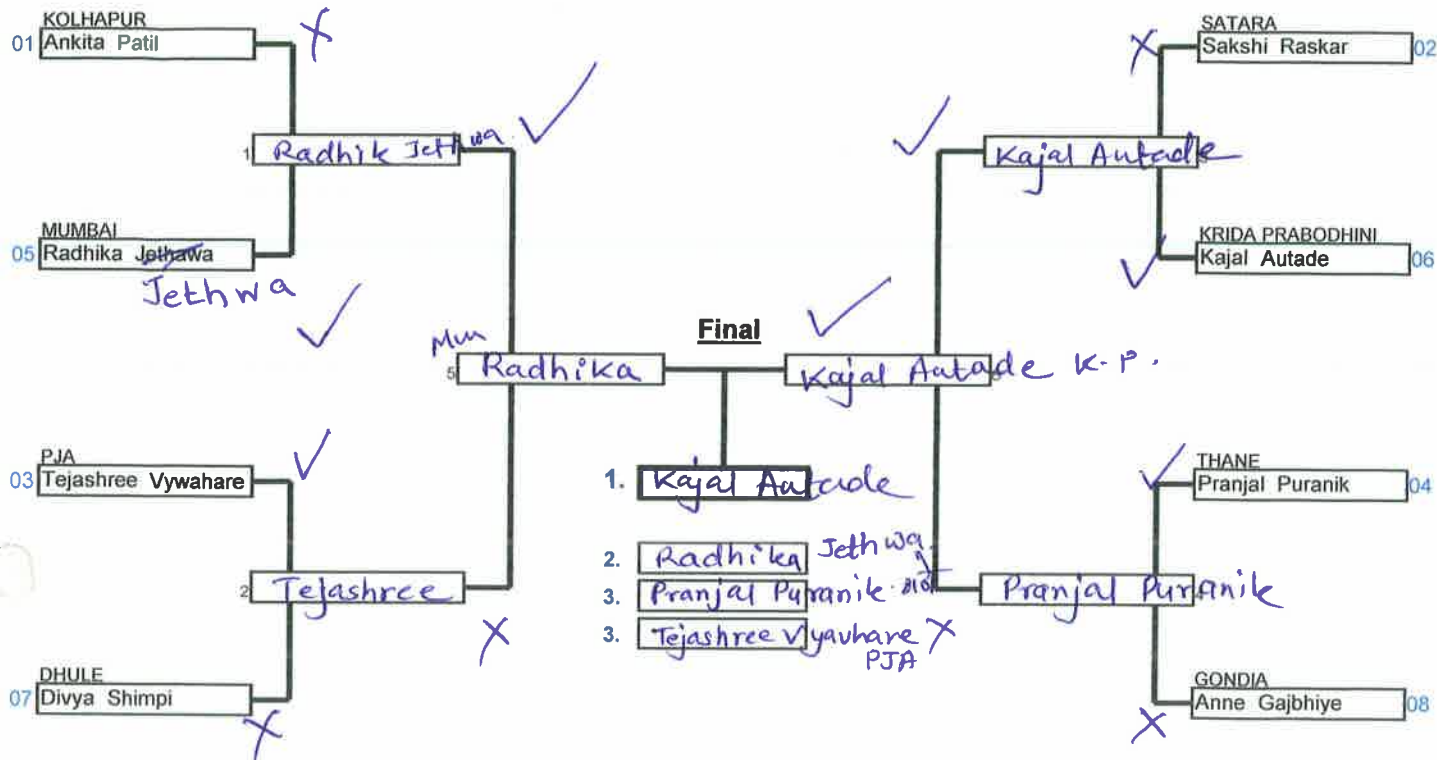

Repechage

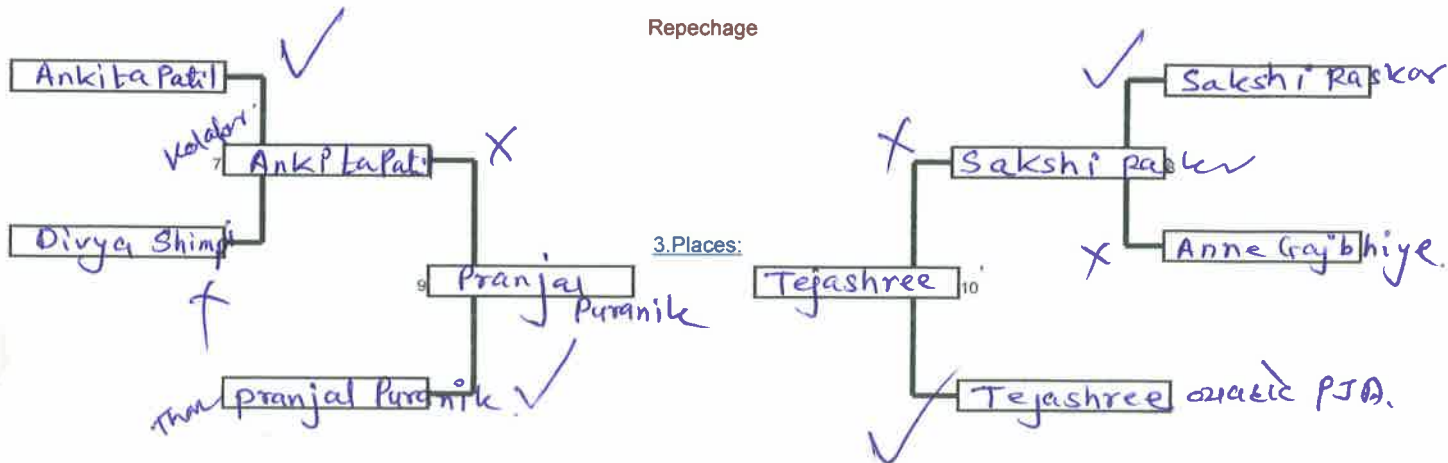

Antes
Nilesh Shelke

Madhusini K.

Sankar

BPatil

TD

Spl...

ADSakpal PJA

OK

45th Cadet and Junior State Championship 2017-18, Nashik

MAT NO. 1

DATE: 17-DEC-2017

wt. Category	Age Group	Name of the Player	Rank
		Cadet Girls	
-70	11/2/2000	RUCHA DHOPESHWAR	GOLD
-70	12/12/2000	BHARTI BOROSE	SILVER
			BRONZE
			BRONZE

PJJA 09
AURAGABAD 56

wt. Category	Age Group	Name of the Player	Rank
		Cadet Girls	
Above 70	07/06/02	APOORVA PATIL	GOLD
+70	29/03/02	SHAMBHAVI KADAM	SILVER
+70	07/07/2002	ISHITTA KAPTA	BRONZE
+70	26/09/2002	DIVYA KARDEL	BRONZE

Thane 36
MUMBAT 57
NAGPUR 113
NASHIK 114

wt. Category	Age Group	Name of the Player	Rank
		Cadet Boys	
-90	27/03/2000	Sourabh Mane	GOLD
-90	15/10/2001	Parth Dabhade	SILVER
-90	16/9/2001	Megharaj Padule	BRONZE
-90	10/7/2001	Mayuresh Kasar	BRONZE

Satara 11
Nashik 58
PJA 115
Kolhapur 110

wt. Category	Age Group	Name of the Player	Rank
			GOLD
			SILVER
			BRONZE
			BRONZE

[Signature]

MAT CHAIRMAN
(NILESH SHELKE)

[Signature]
(Amal Desai)

[Signature]

T. D. Patil
TD. 17/12/17.

Preliminaries and final

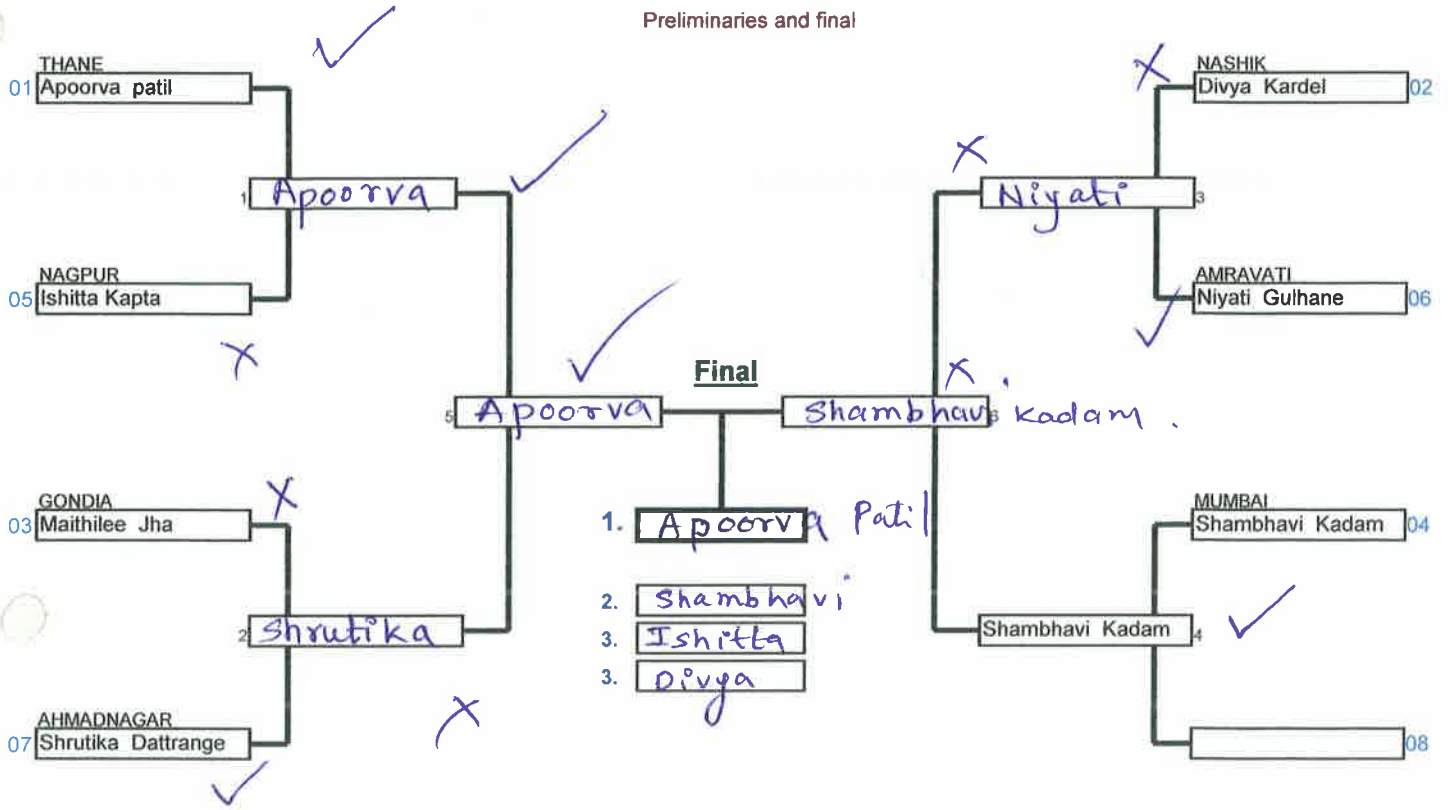

Repechage

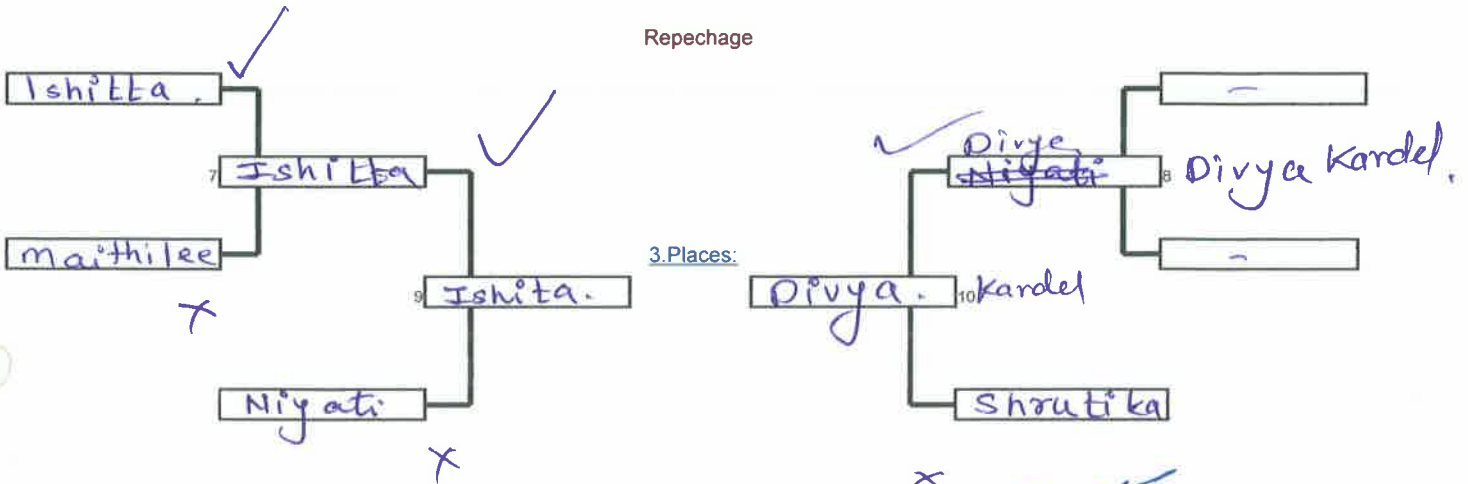

Artes
Adkashid
Amol Jassi

JPatil
720

Poolk.

Nr. Name	Club	01	02	03	Wins / Pts	Weight	Place
01 Bharti Borase	AURANGABAD		0	0	0 0	kg	
02 Rucha Dhapeshwar	PDJA	●		0	0 0	kg	
03 Habiba Shaikh	MUMBAI	0	0		0 0	kg	

Matches:

Round/Compe	Name ("blue")	Name ("white")	Winner	Pts.	Scores
1 01-02	Bharti Borase X	Rucha Dhapeshwar ✓	Rucha D.	Ippon	
2 02-03	Rucha Dhapeshwar ✓	Habiba Shaikh X	Rucha D		
3 03-01	Habiba Shaikh X	Bharti Borase ✓	Bharti B.		

1. Rucha
2. Bharati
3. Habiba

Amal Desai

R. Desai

Amal Desai

S. Khan

W. Patil
T2

Preliminaries and final

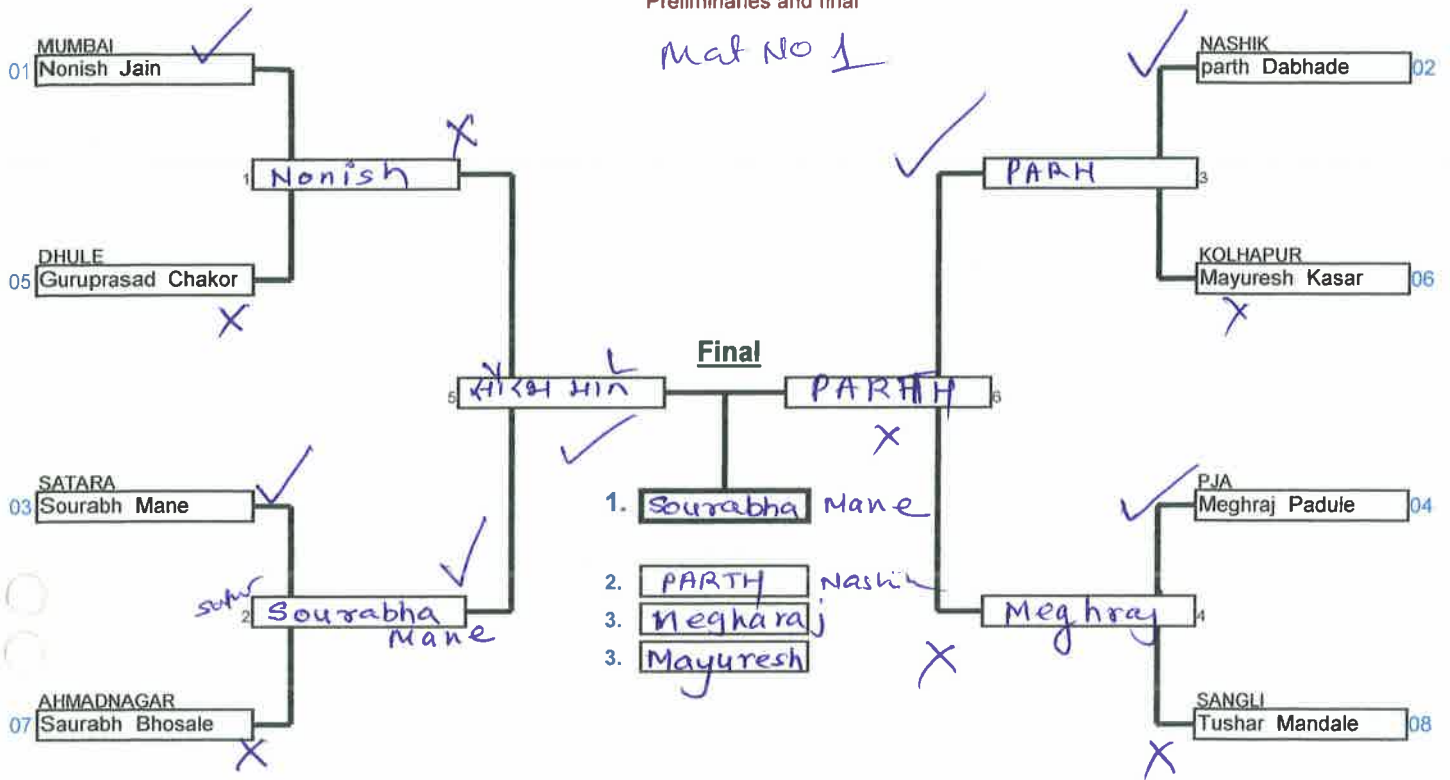

Repechage

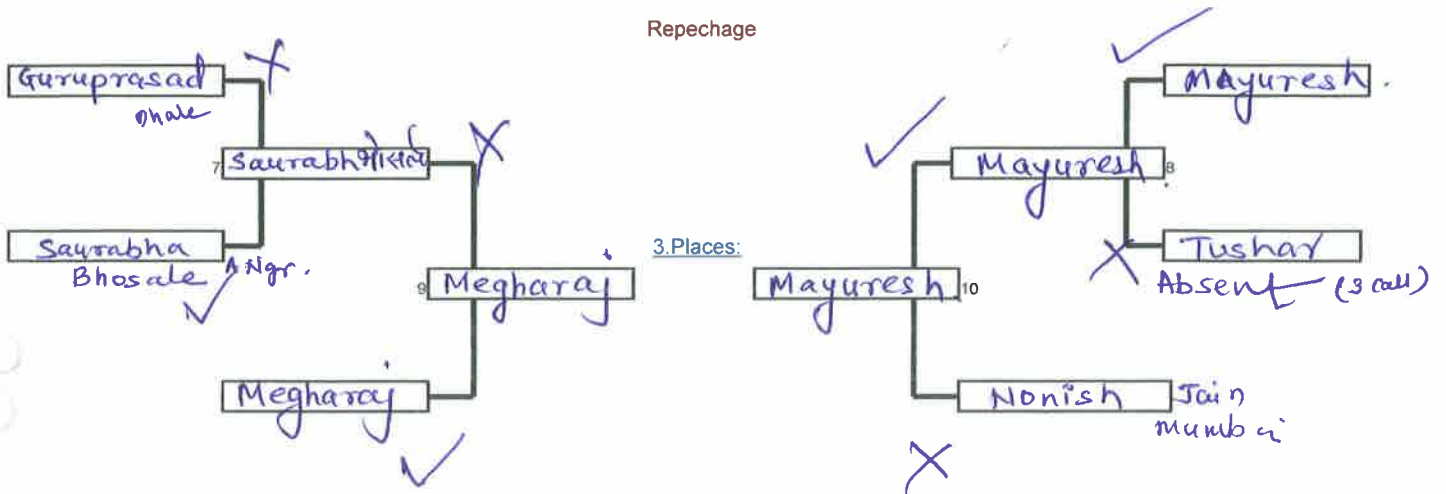

Amol Desai

B.Patil
T.O.

Mearana

Jr. Girls U/21

45th Cadet and Junior State Championship 2017-18, Nashik

MAT NO. 23

DATE: 17-12-2017. Jr Girls

wt. Category	Age Group	Name of the Player	Rank
+78	U/21		
	4/10/2001	Aathashree Deshmukh	GOLD
	8/11/1977	Gurupreet Kaur Saini	SILVER
	7/11/1987	Himani Gaonkar.	SILVER BRONZE
	8/11/93	Gurupreet	BRONZE

Mumbai 08
Phule 108
Thane 53
Phule 08

Nati. sel. - Himani Gaonkar.

wt. Category	Age Group	Name of the Player	Rank
			GOLD
			SILVER
			BRONZE
			BRONZE

wt. Category	Age Group	Name of the Player	Rank
			GOLD
			SILVER
			BRONZE
			BRONZE

wt. Category	Age Group	Name of the Player	Rank
			GOLD
			SILVER
			BRONZE
			BRONZE

Jmr.
(Narsing)

B.Patil
TD.

Poolk.

Nr. Name	Club	01	02	03	04	05	Wins / Pts	Weight	Place
01 Sasha Aher	NASHIK		0	0	0	0	0 1	kg	
02 Himani Gaonkar	THANE	0		0	0	0	0 2	kg	II
03 Aaathashree Deshmukh	MUMBAI	0	0		0	0	0 4	kg	I
04 Pratiksha Pawar	SATARA	0	0	0		0	0 0	kg	
05 Gurupreetkaur Saini	DHULE	0	0	0	0		0 2	kg	III

Matches:

Round/Compe	Name ("blue")	Name ("white")	Winner	Pts.	Scores
1	04-05 Pratiksha Pawar	Gurupreetkaur Saini	Saini	I	
	01-02 Sasha Aher	Himani Gaonkar	Himani	I	
2	03-04 Aaathashree Deshm	Pratiksha Pawar	Deshmukh	W	
	05-01 Gurupreetkaur Saini	Sasha Aher	Saini	I	
3	02-03 Himani Gaonkar H	Aaathashree Deshm	Deshmukh	P	
	04-01 Pratiksha Pawar H	Sasha Aher	Sasha	W	
4	03-05 Aaathashree Deshm	Gurupreetkaur Saini	Deshmukh	I	
	02-04 Himani Gaonkar	Pratiksha Pawar	Gaonkar	I	
5	01-03 Sasha Aher	Aaathashree Deshm	Deshmukh	I	
	05-02 Gurupreetkaur Saini	Himani Gaonkar	Saini Himani	I	

1. Aaathashree Deshmukh
2. Gurupreetkaur Saini
3. Himani Gaonkar

Ist Athashree
 II - Himani Gaonkar
 III - Gurupreet Saini

04/10/01 Ist Place - Aaathashree Deshmukh - (Mumbai)
~~X 08/11/97 IInd place - Gurupreet Kaur Saini (Dhule)~~
~~X 07-11-98 IIIrd place - Himani Gaonkar (Thane)~~
 ✓ 07-11-98 - IInd place - Himani Gaonkar (Thane)
 ✓ 08-11-97 - IIIrd place - Gurupreet Kaur Saini (Dhule)

National Selection - Gurupreet Saini
 - Himani Gaonkar } Himani Gaonkar (Thane) selected for National

Patil
 TD 17/12/17 *Ym*

Jr. girls u/21	70 To 78 Kg girls	45th Junior Girls and Boy	Meetai Thakare Stadi	15/12/2017	1	Cmp
Round Robin System for 2 Competitors				4 min	Matte _	

Sakshi Sanjay Sarwad - mumbai

OK

45TH CADET AND JUNIOR STATE CHAMPIONSHIP 2017-18, NASHIK

MAT NO. 3

DATE: 16/12/2017

Junior Boys

wt. Category	Age Group	Name Of the Player	District	Rank
-50kg	Junior	-	-	-
	10/1/2000	Somnath Magdum	Kolhapur	GOLD
	29/10/2000	Nayan Dhabade	Bhandara	SILVER
	13/9/98	Jay Khodake	Yavatmal	BRONZE
	16/9/98	Harish Chaudhari	Dhule	BRONZE

16
65
129
130

wt. Category	Age Group	Name Of the Player	District	Rank
-55kg	Junior	-	-	-
	23/8/97	Shravan Shedge	A'bad	GOLD
	24/4/98	Dushyant Mhatre	Mumbai	SILVER
	26/8/99	Avdhit Patil	Kolhapur	BRONZE
	22/11/99	Gaurav Pagare	Nashik	BRONZE

10
66
131
132

wt. Category	Age Group	Name Of the Player	District	Rank
-60kg	Junior	-	-	-
	27/12/99	Ajinkya Mate	Aurangabad	GOLD
	18/1/99	Aniket Gupta	Mumbai	SILVER
	5/3/99	Satish Thakare	Nashik	BRONZE
	16/3/98	Ranvirsing Bhosale	Kolhapur.	BRONZE

18
68
135
136

(Signature)

MAT CHAIRMAN

(Narsing)

(Signature)
PJA

(Signature)
16/12/2017

TOURNAMENT DIRECTOR

(Signature)

MAT - 3

Jr. boys u/21	below 50	45th Junior Girls and Boy	Meetai Thakare Stadi	15/12/2017	16 Cmp.
Elimination System with Double Repechage for 9 to 16 Competitors				4 min	Matte

Preliminaries and final

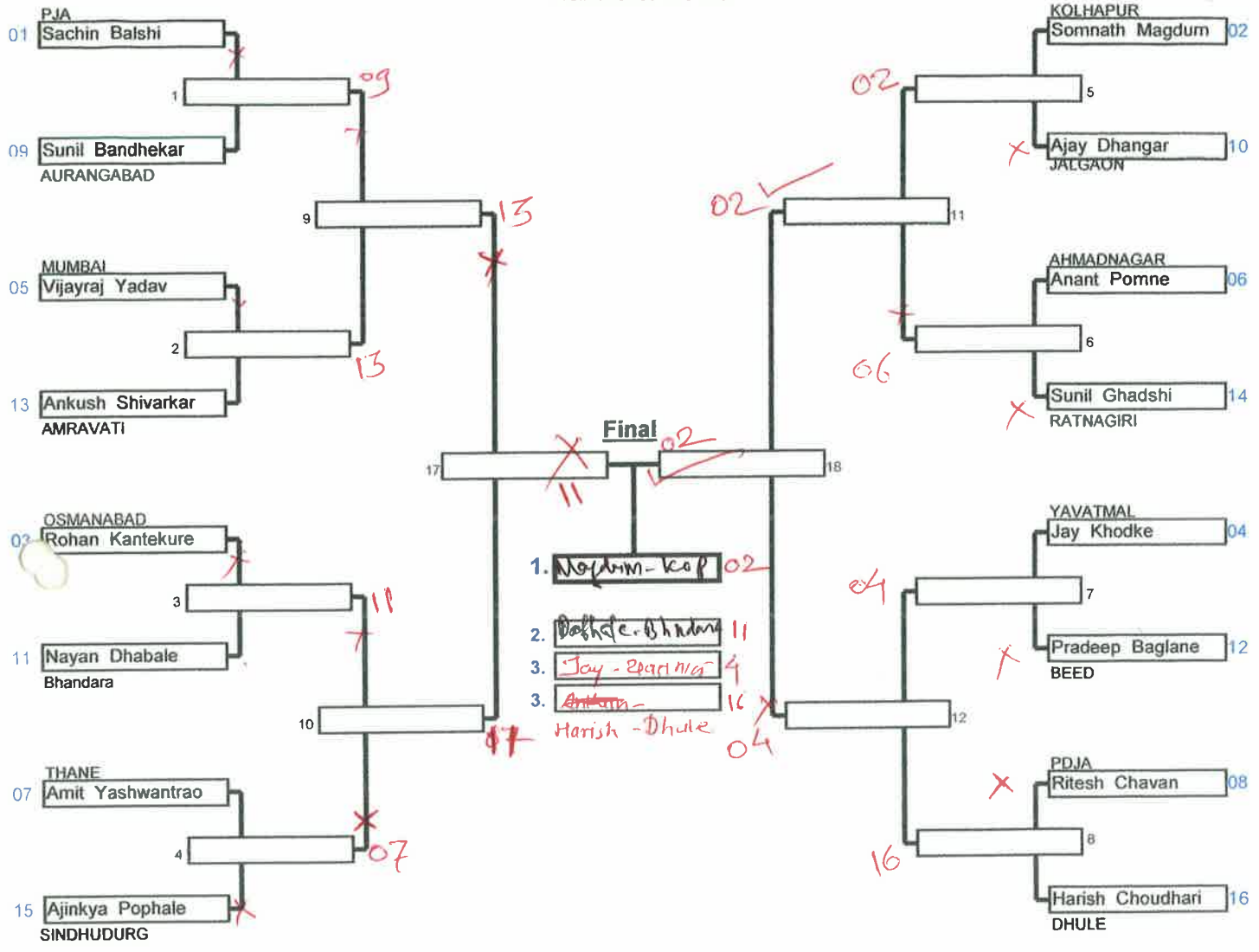

Repechage

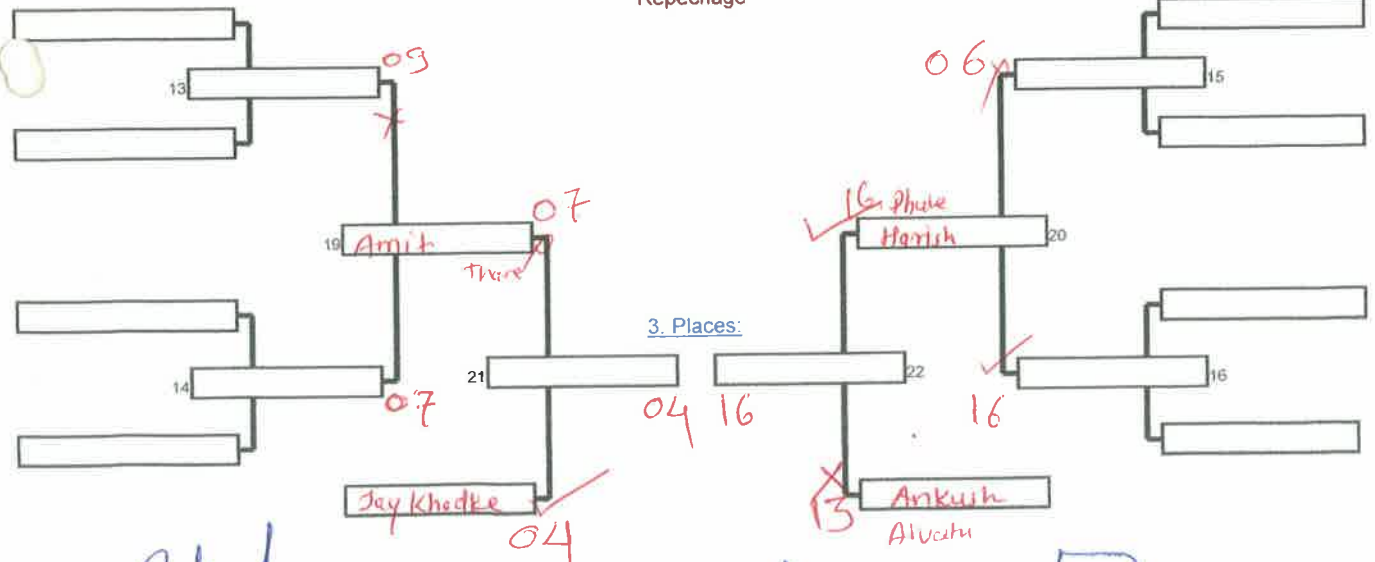

Patil
BP Patil / AD Sakzad PTA
Juni (Warsing)

Preliminaries and final

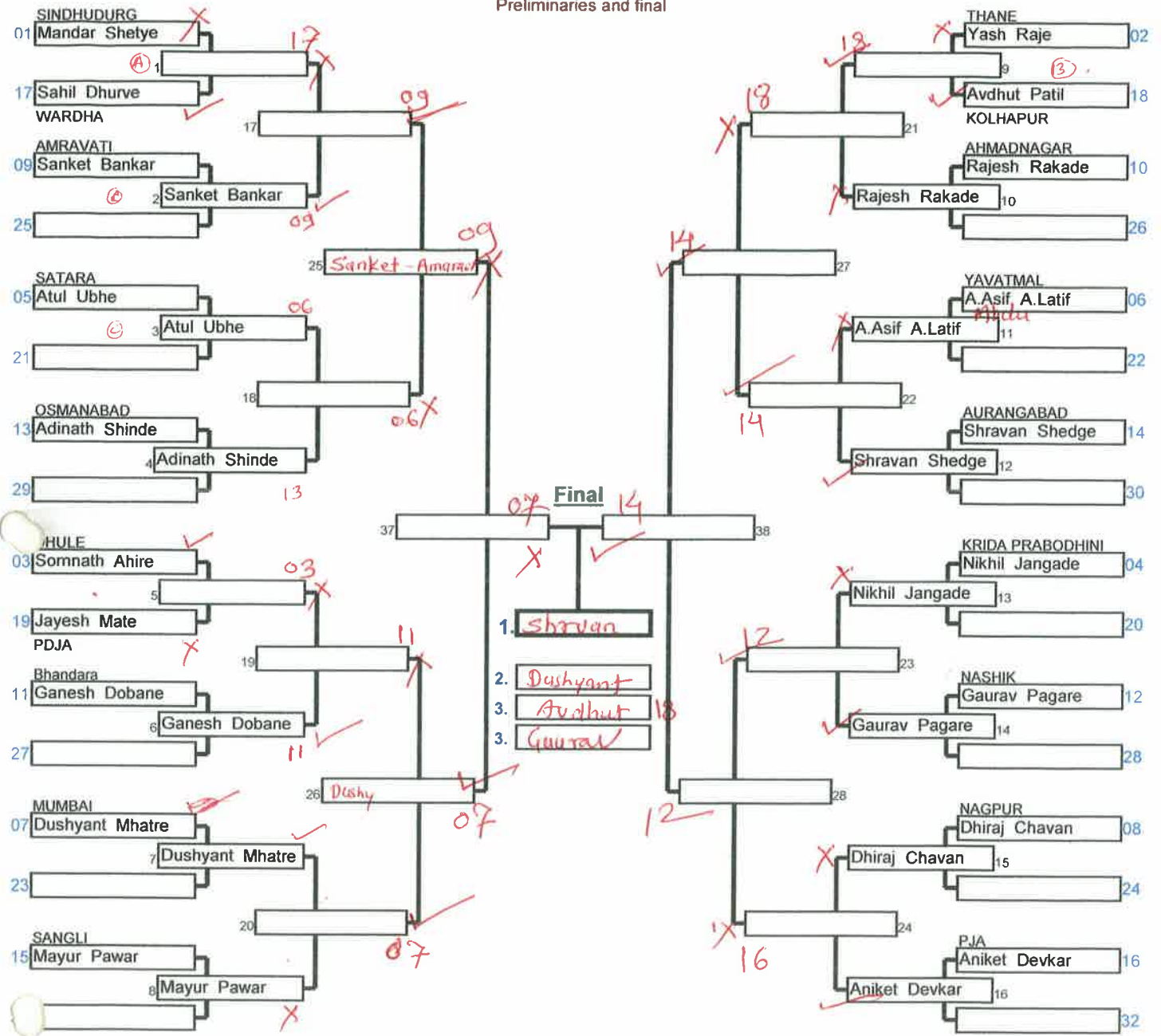

Repechage

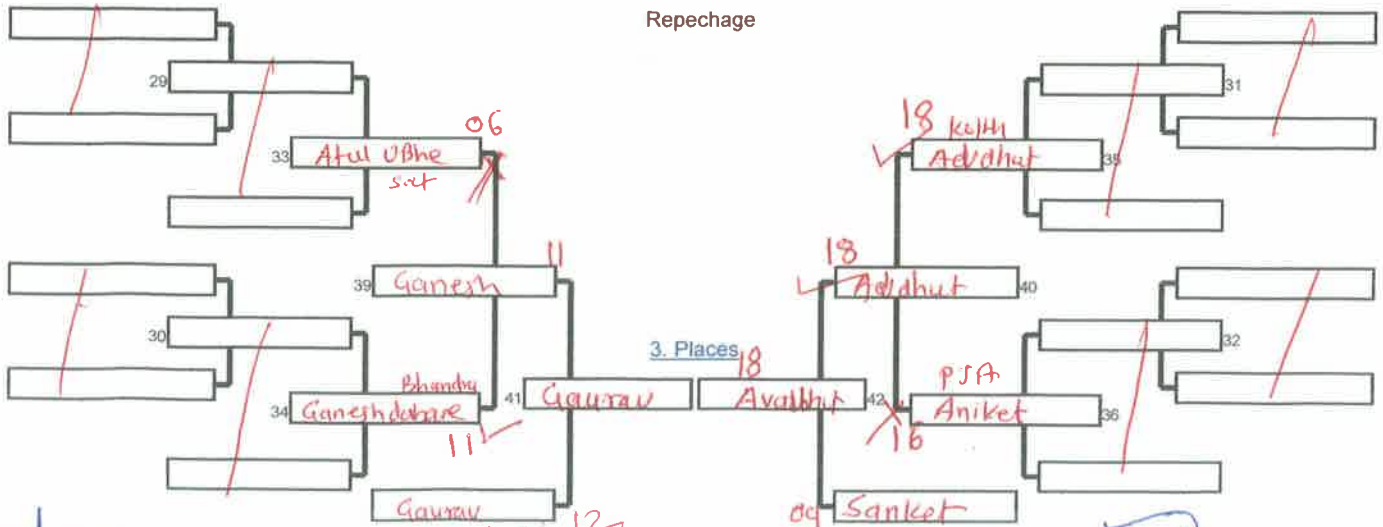

Preliminaries and final
Mat No 1

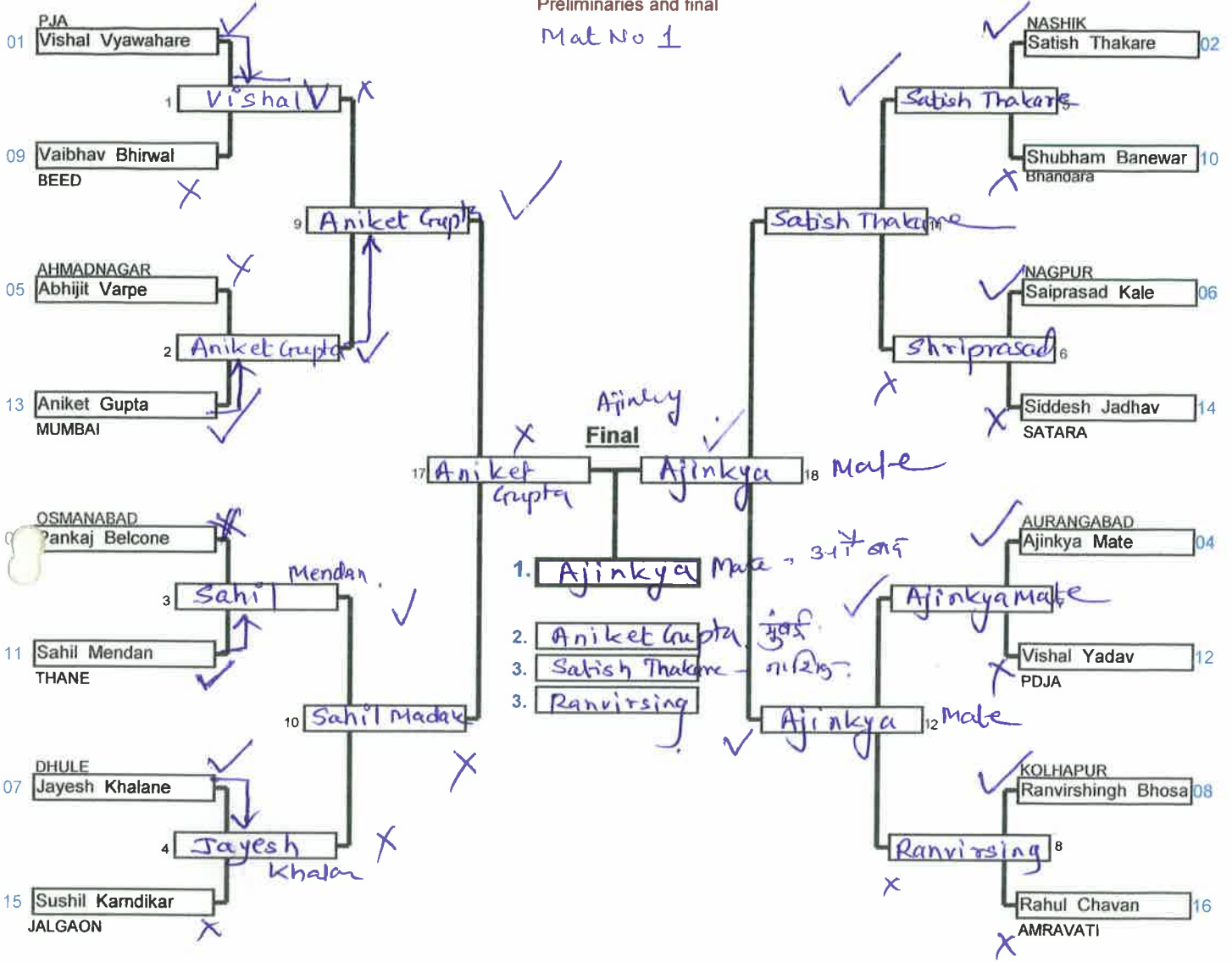

Repechage

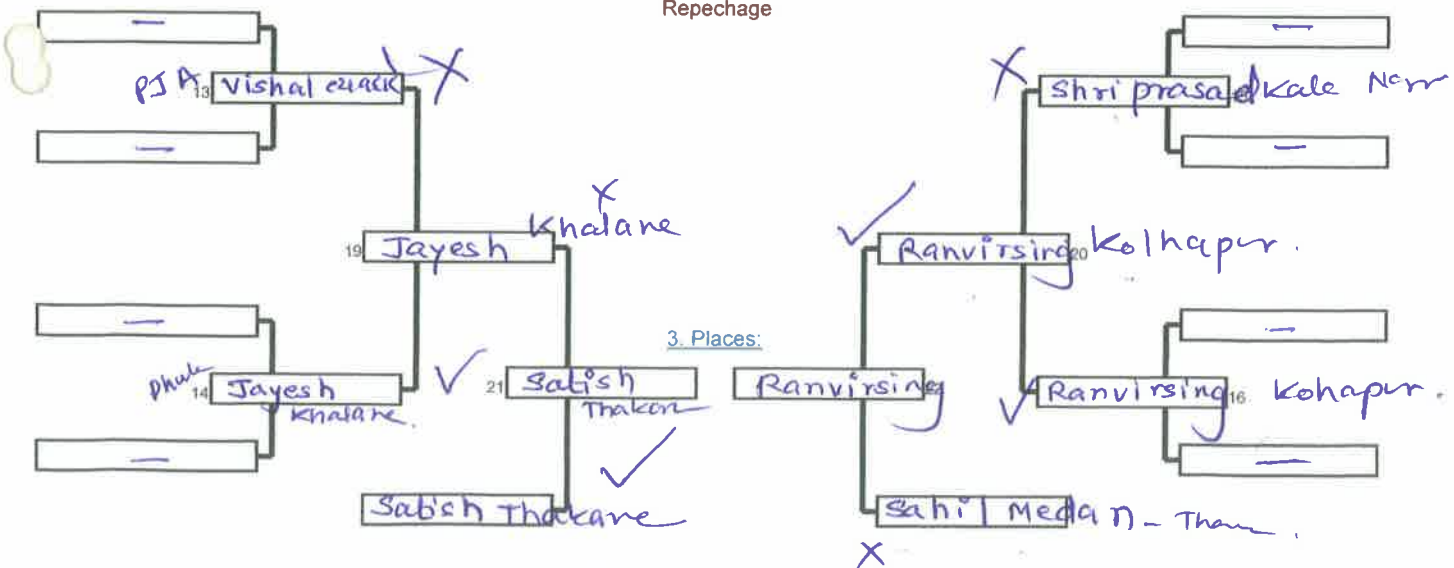

AD Sakpal
PJA
16/12/17
TD

ok

45th Cadet and Junior State Championship 2017-18, Nashik

MAT NO. 2

DATE: 17/12/2017 Junior Boys

wt. Category	Age Group	Name of the Player	Rank
-66 kg	JUNIOR		
22 -66 kg	13/3/98	AJINKYA VAIDYA	22 GOLD
42 "	27/10/97	GURUPRASAD DESAI	SILVER
56 "	11/3/98	SAURABH DEOTALE	BRONZE
112 7 "	27/4/99	ASHISH UGADE	BRONZE

ok
NASHIK
KOLHAPUR
WARHA
AURANGABAD

wt. Category	Age Group	Name of the Player	Rank
-73 kg	JUNIOR		
24	18/8/97	ROHAN BENDRE	GOLD
45	3/4/98	TRIBHUVAN BANGERA	SILVER
38	20/7/99	ADITYA SAID	BRONZE
39	30/4/98	HINDURAO SHINGE	BRONZE

ok
KOLHAPUR
MUMBAI
AHMEDNAGAR
PJA

wt. Category	Age Group	Name of the Player	Rank
-81 kg	JUNIOR		
23	13/9/98	HARSHAL THITE	GOLD
54	09/3/97	SWARNIL MANDHARE	SILVER
98	03/04/97	FAYAZ SHAIKH	BRONZE
85	22/09/98	PRAJWAL TALOKAR	BRONZE

ok
AURANGABAD
THANE
MUMBAI
KRIYA PRODHIND

wt. Category	Age Group	Name of the Player	Rank
Above 90 kg	CADET (ABOVE +90 KG)		
	21/03/01	ADNAN SHAIKH	GOLD 26
	16/11/02	DEVRAJ KADAM	SILVER 49
	10/10/01	OMSINGH CHOUHAN	BRONZE 9
	05/01/01	SOMNATH AVSARE	BRONZE 102

selected for Nationals

ok
MUMBAI
PJA
AMRAVATI
PJA

B Patil
TL

Sub-
17/12/17

AD

Preliminaries and final

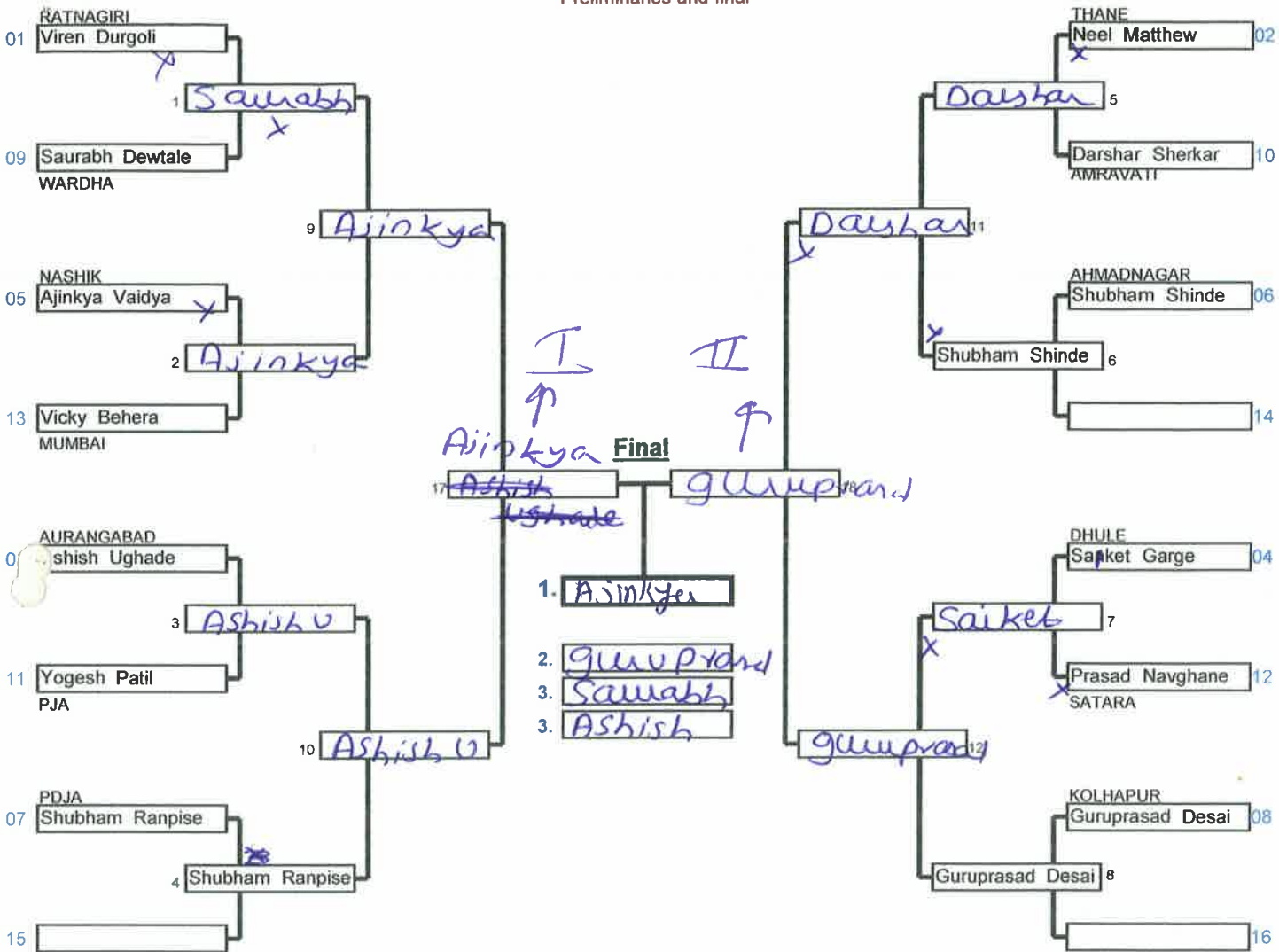

Repechage

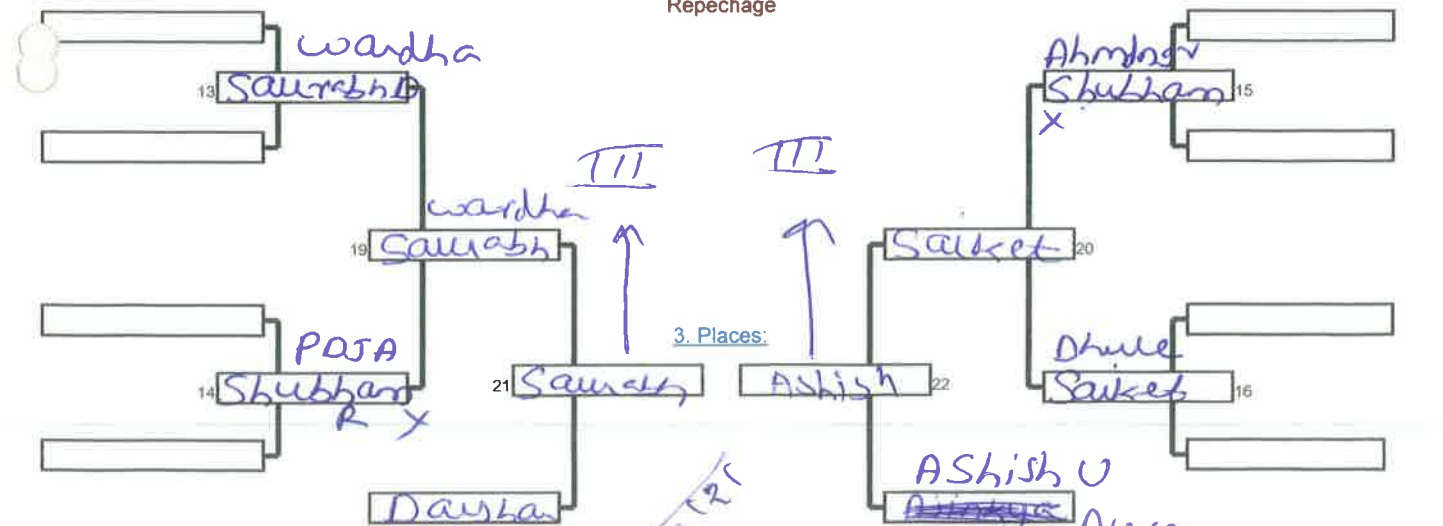

[Handwritten signature]

[Handwritten signature]

[Handwritten signature]

[Handwritten signature]

[Handwritten signature]

[Handwritten signature]

Preliminaries and final

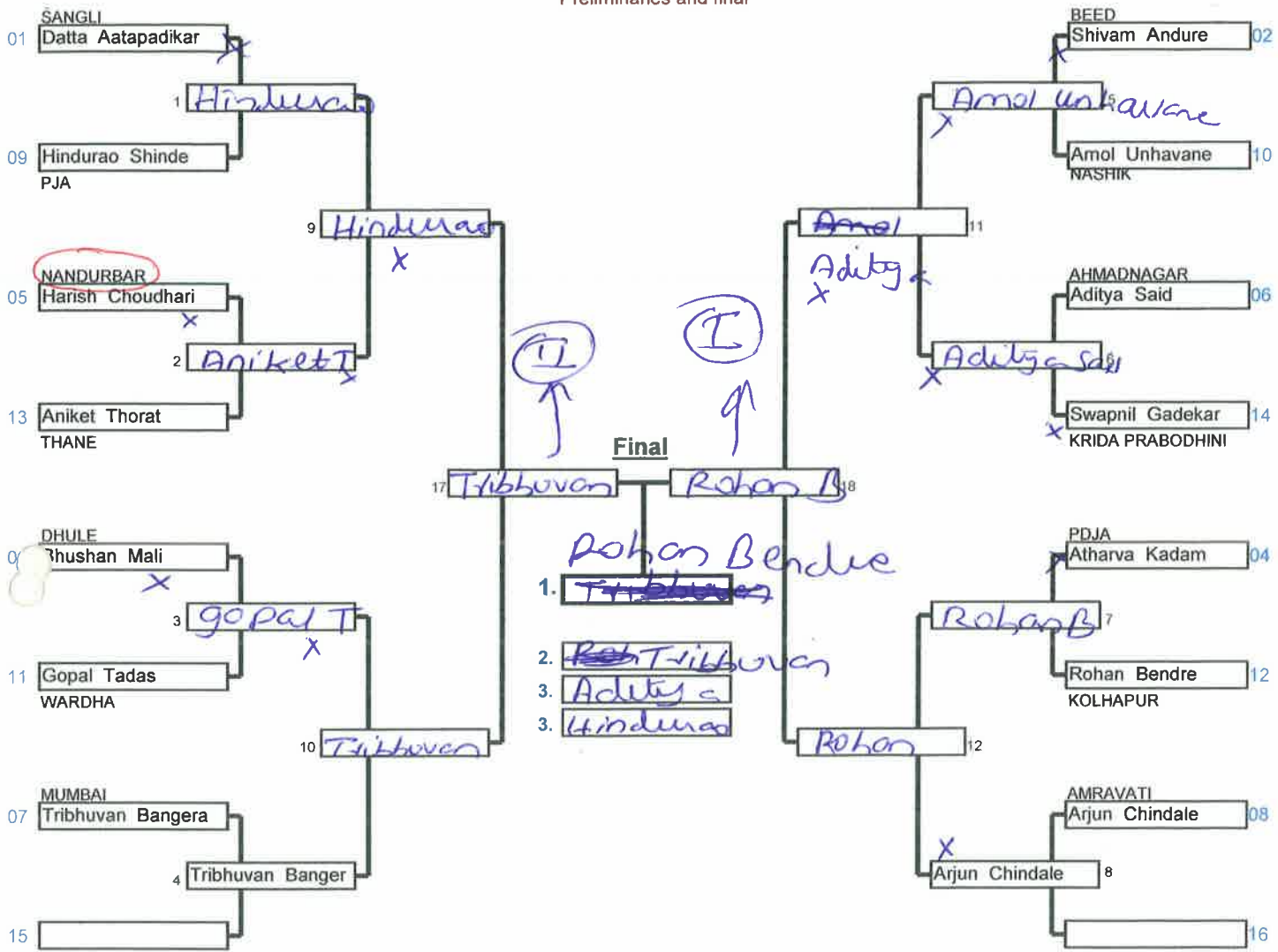

Repechage

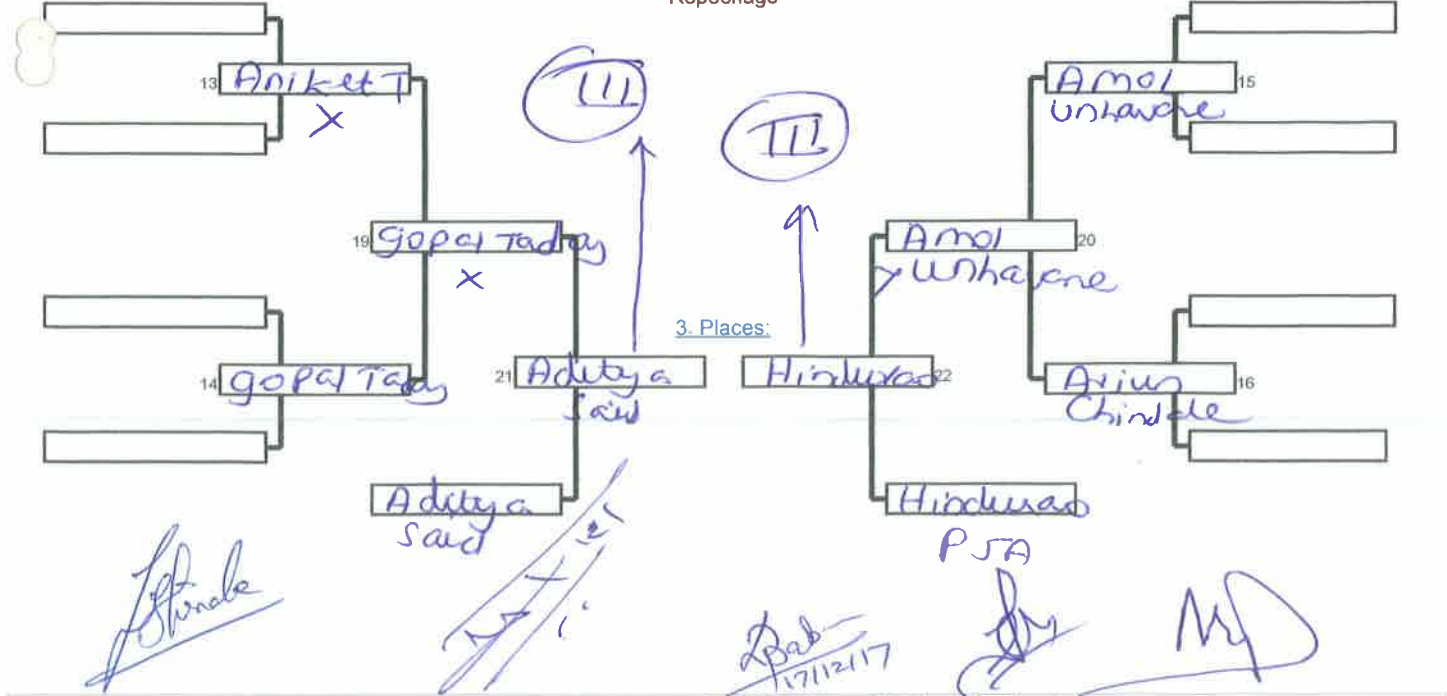

Handwritten signature and date:
 J. B. Patil
 17/12/17

Preliminaries and final

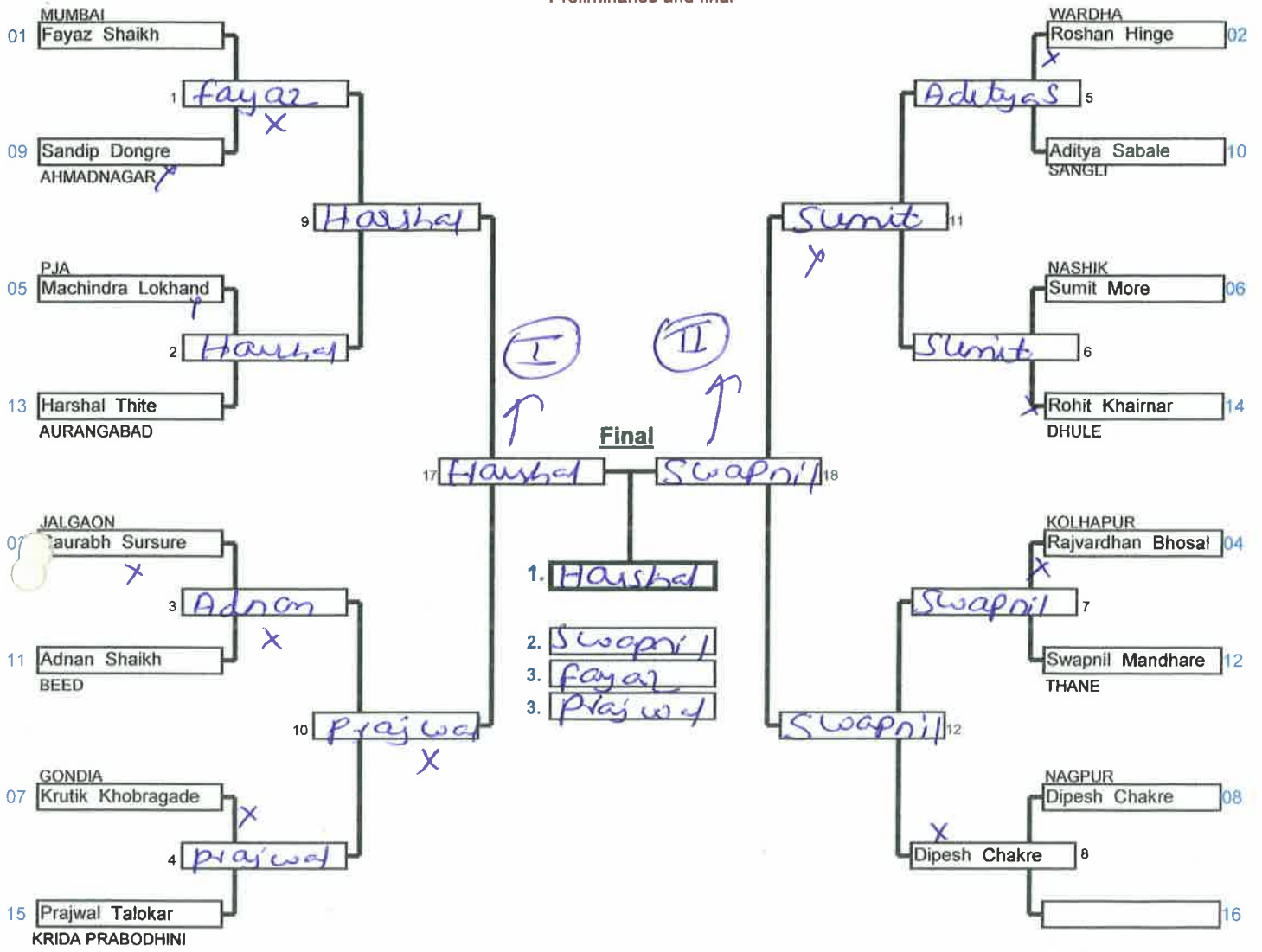

Repechage

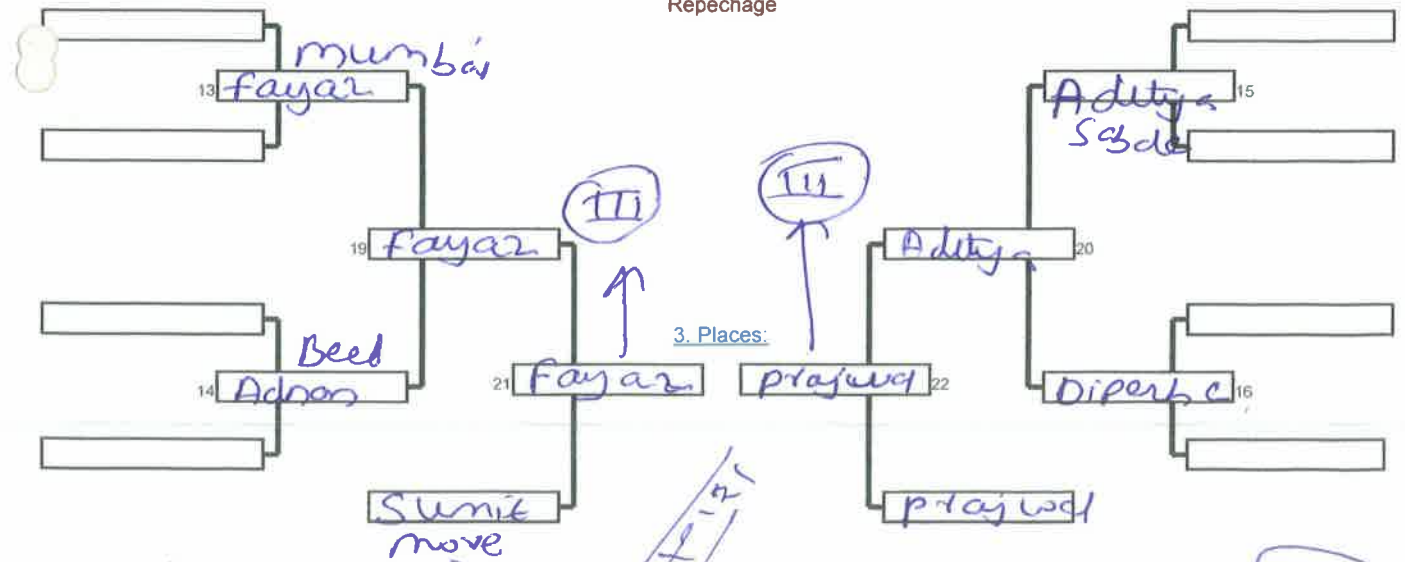

Handwritten signature: B. Patil
 Date: 17/12/17

Preliminaries and final

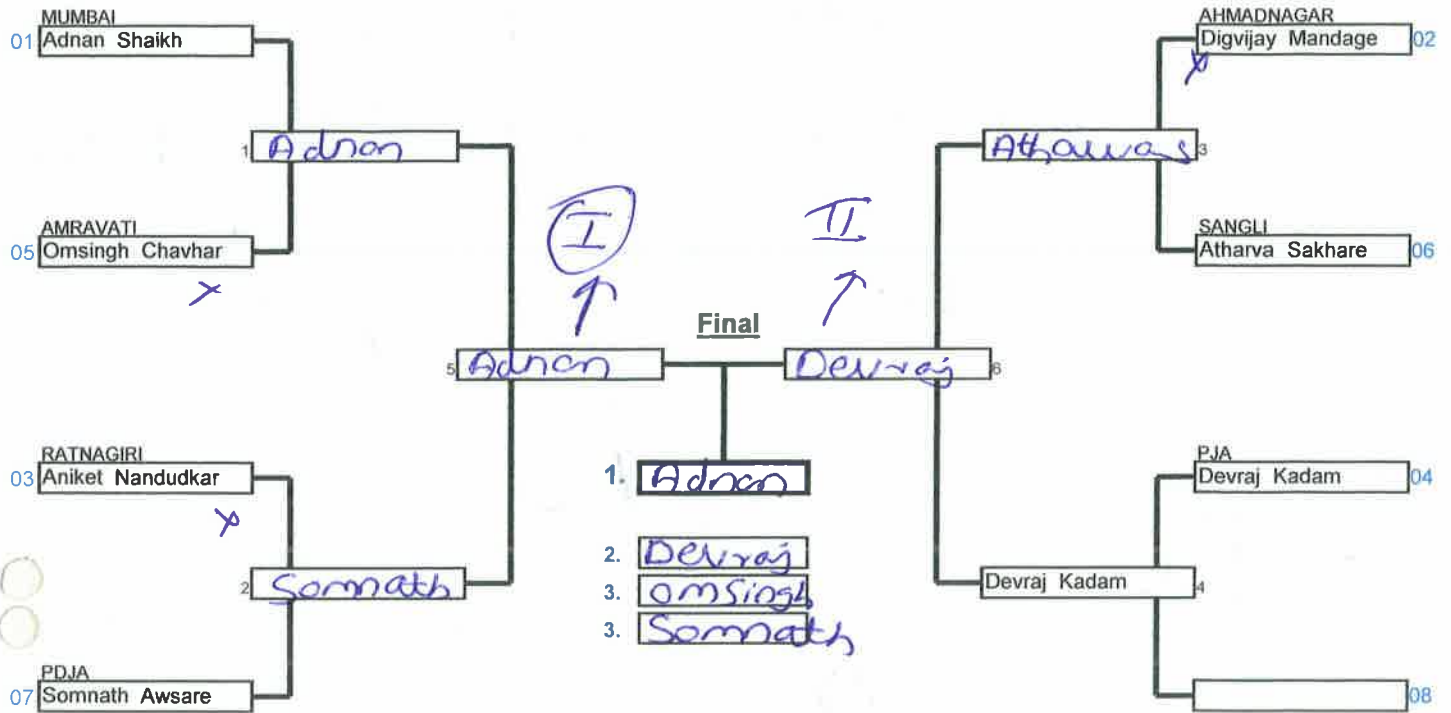

Repechage

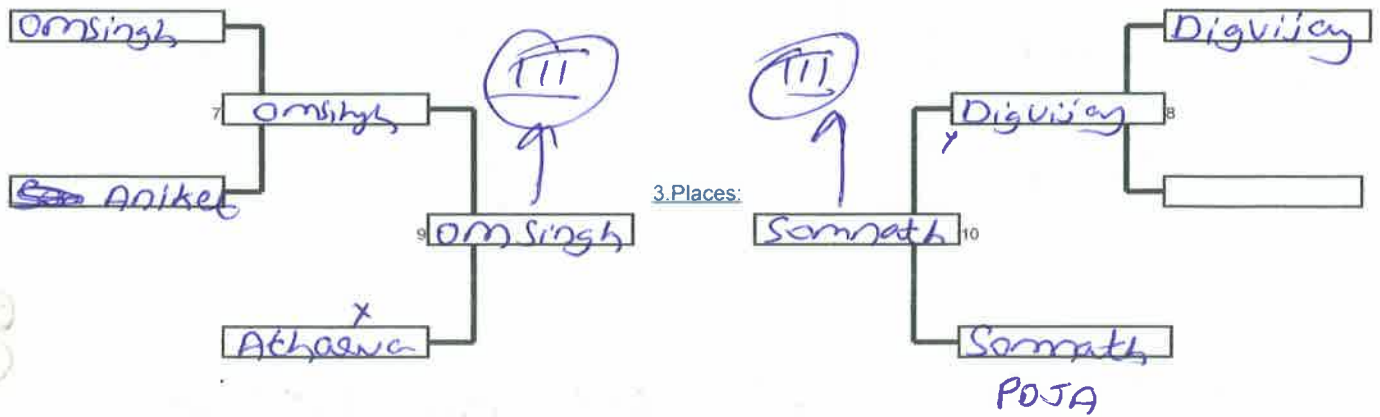

Handwritten signatures and notes:

- Adnan
- 17/12/17
- BPatri
- TW

Jr. Boys u/21 - 90 Kg.

OK

45th Cadet and Junior State Championship 2017-18, Nashik

MAT NO. 3

DATE: - 17-12-2017 Jr Boy

wt. Category	Age Group	Name of the Player	Rank
- 90	U/21		
07/6/99	Kolhapur	Tushar Satpute.	GOLD 25
11/6/99	Mumbai	Tabish Shaikh	SILVER 47
11/2/03	P.T	Amar Shelar.	BRONZE 92
29/7/97	Dhule	Vaibhav Birari.	BRONZE 93

BIRARI

wt. Category	Age Group	Name of the Player	Rank
+ 100	U/21		
27	4-4-1997	Sarfraz Khan, Aur.	GOLD
52	14-11-1999	Janak Dhokra - Thane.	SILVER
154 (05)	02-09-1999	Abhishek Kalbande - Nag.	BRONZE
106	5-12-1999	Vikrant Ingawale - Kolh.	BRONZE

wt. Category	Age Group	Name of the Player	Rank
- 100	U/21		
28	24/3/97	Pratyush Patil.	GOLD Thane
			SILVER
			BRONZE
			BRONZE

wt. Category	Age Group	Name of the Player	Rank
			GOLD
			SILVER
			BRONZE
			BRONZE

Patil (Narsing)

B. Patil
T.O. 17/12/17.

Preliminaries and final

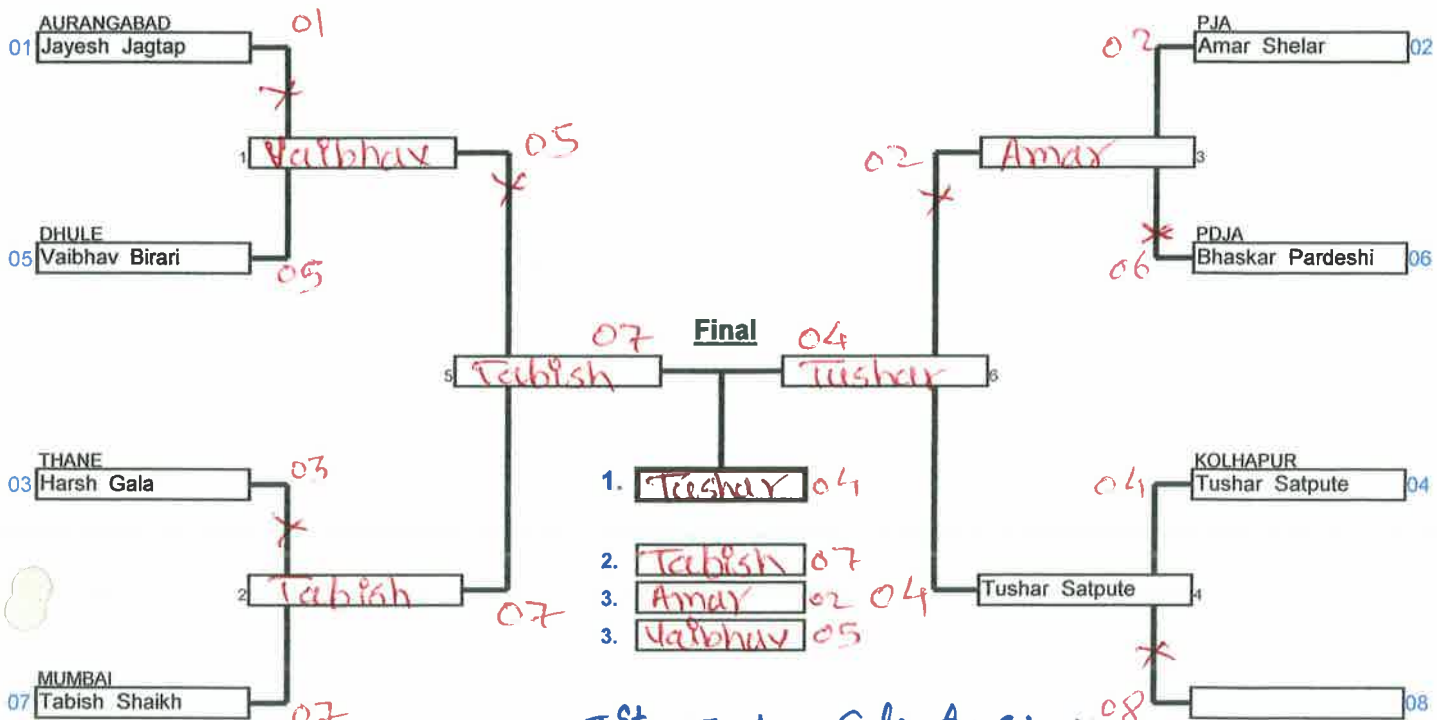

- Ist - Tushar Satpute (Kolhapur)
 IInd - Tabish Shaikh (Mumbai)
 IIIrd - Amar Shelar (PJA)
 IIIrd Repechage - Vaibhav Birari (Dhule)

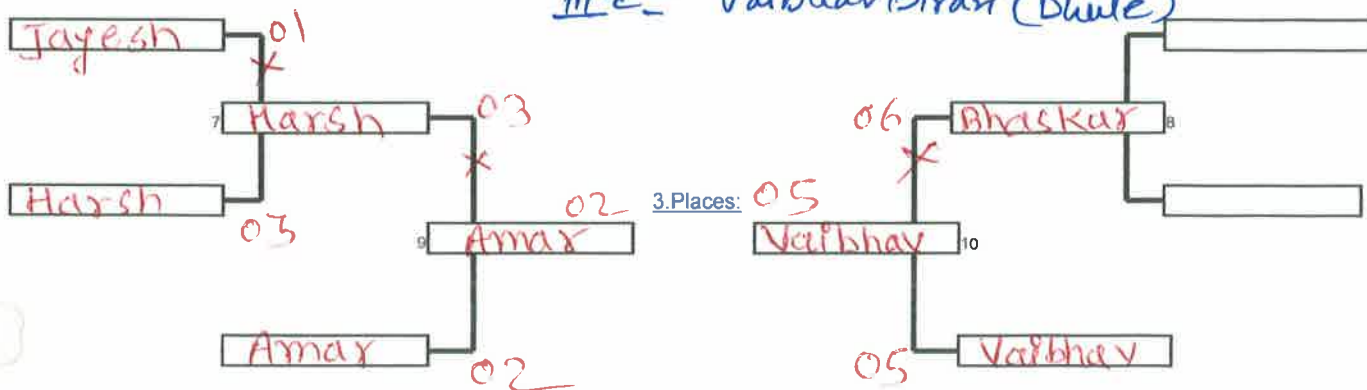

Prabhat

TB Patil
 TLD

Jud
 (Narsing)

Preliminaries and final

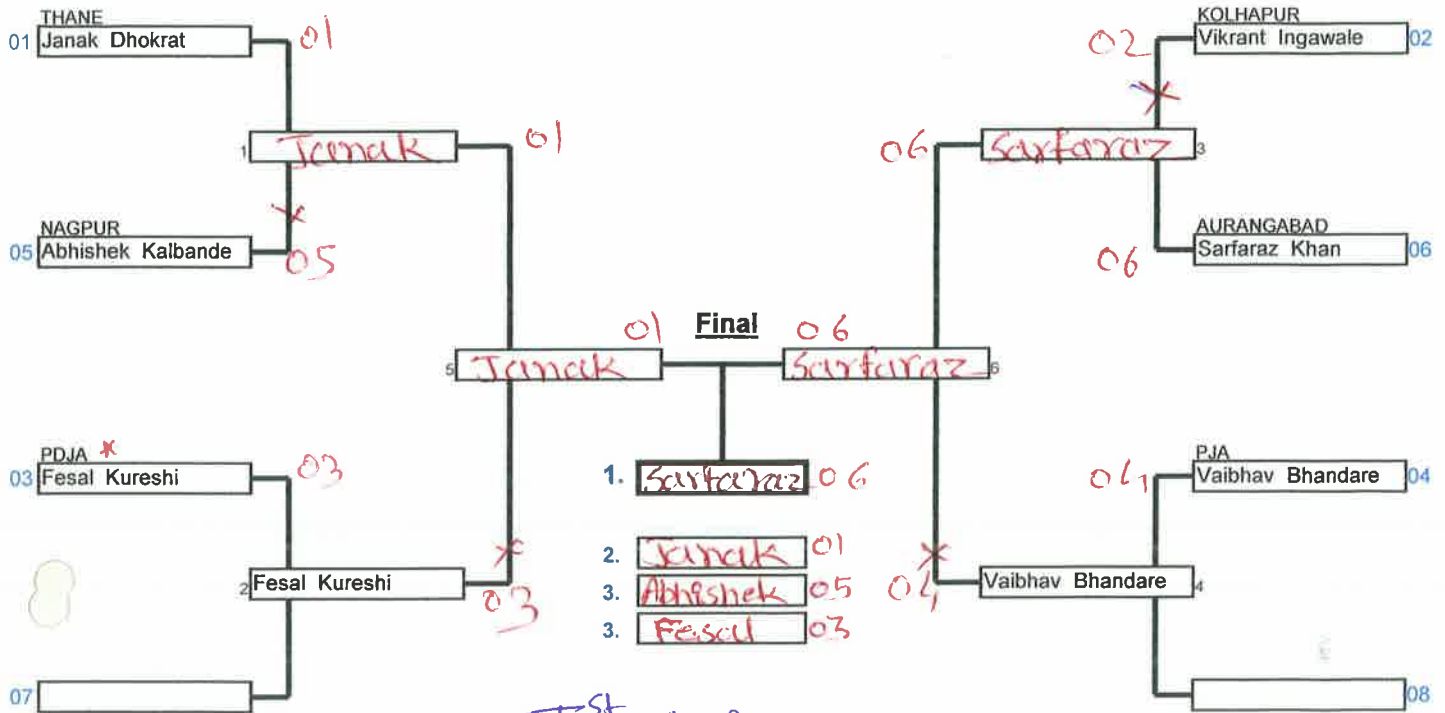

Ist - Sarfaraz Khan - (Aurangabad)
 IInd - Janak Dhokrat - (Thane)
 IIIrd - Abhishek Kaibande (Nagpur)
 IIIrd - Vikrant Ingawale (Kolhapur)

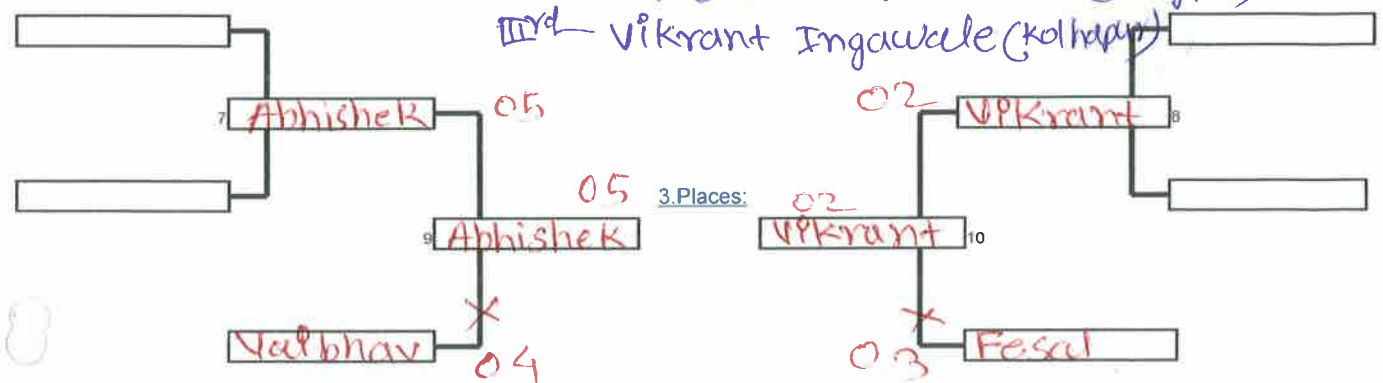

Patil

Janak

B. Patil
 T/W.

Poolk.

No. Name	Club	01	02	Wins / Pts	Weight	Place
01 Swapnil Phule	PJA		0	0 0	kg	
02 Pratyush Gaikwad	THANE	0		0 0	kg	

Matches:

Round/Compe	Name ("blue")	Name ("white")	Winner	Pts.	Wertungen
1 01-02	Swapnil Phule	Pratyush Gaikwad	Pratyush	I	
2 01-02	Swapnil Phule	Pratyush Gaikwad			
3 01-02	Swapnil Phule	Pratyush Gaikwad			

1. Pratyush Gaikwad
2. Thane
- 3.

* Round 3 only required in case of a draw after the second round

1st - Pratyush Gaikwad (Thane)

Jud
(Narsing)

Patil

Patil
TD.

OK

45th Cadet and Junior State Championship 2017-18, Nashik

MAT NO. 3

DATE: 16/12/2017 Junior Girls

wt. Category	Age Group	Name of the Player	Rank
		Junior Girls	
-40	U/21	Sakshi Deshmukh ^{26/11/2002}	GOLD 29
	5/3/98	Amushri Babekar	SILVER 59
	3/12/2001	Sonali Gorale	BRONZE 118
			BRONZE 118

KoPo
Amravati
Nashik

wt. Category	Age Group	Name of the Player	Rank
		Junior Girls	
-44	U/21	Namita Narsale	GOLD 02
	15/10/99	Dhanashri Wadkar	SILVER 43
	24/11/2000	Smita Lonhe	BRONZE 81
	24/2/99	Ankita Kumbar	BRONZE 82
	24/11/98	Shraddha Giri	156

A. Nagar
KoPo
P. Jo A
Mumbai
Kolhapur.

wt. Category	Age Group	Name of the Player	Rank
		Junior Girls	
-48	U/21	Vidya Lohar ^{18/12/98}	GOLD 02
	23/4/99	Sonali Narate ^{नरते}	SILVER 44
	27/1/99	Pragati Sawarkar	BRONZE 86
	8/4/98	Komal Mokashi	BRONZE 87

Nashik.
Po Jo A
Amravati
KoPo

wt. Category	Age Group	Name of the Player	Rank
		Junior Girls	
-52	U/21	Sonali Magdum ^{15/8/99}	GOLD 04
	23/12/98	Pooja Urkude	SILVER 46
	15/12/98	Rasika Sangale	BRONZE 90
	21/6/99	Rupali Warde	BRONZE 91

Kolhapur
KoPo
Po Jo A
Aurangabad.

Amte
(Passing)
Mat Chairman

Patil
16/12/2017
T/O.

AD Sakpal
8 OA

Mat. - 3

Jr. girls u/21	Below 40	45th Junior Girls and Boy	Meetai Thakare Stadi	15/12/2017	5	Cmp
Round Robin System for 5 Competitors				4 min	Matte _	

Poolk.

Nr. Name	Club	01	02	03	04	05	Wins / Pts	Weight	Place
01 Anushri Bahekar	AMRAVATI		0	0	0	0	0 3 0	0 kg	II
02 Sonali Gorale	NASHIK	0		0	0	0	0 2 0	kg	III
03 Sakshi Deshmukh	KRIDA PRABODHINI	0	0		0	0	0 4 0	kg	I
04 Jyoti Hegade	KOLHAPUR	0	0	0		0	0 0 0	kg	
05 Jinnat Pathan	GONDIA	0	0	0	0		0 1 0	kg	

Matches:

Round/Compe	Name ("blue")	Name ("white")	Winner	Pts.	Scores
1	04-05 Jyoti Hegade	Jinnat Pathan ✓	Jinnat Pathan	I	
	01-02 Anushri Bahekar ✓	Sonali Gorale	Anushri B.	I	
2	03-04 Sakshi Deshmukh ✓	Jyoti Hegade	Sakshi D.	I	
	05-01 Jinnat Pathan	Anushri Bahekar ✓	Anushri Ba	I	
3	02-03 Sonali Gorale	Sakshi Deshmukh ✓	Sakshi D.	I	
	04-01 Jyoti Hegade	Anushri Bahekar ✓	Anushri Ba	I	
4	03-05 Sakshi Deshmukh ✓	Jinnat Pathan	Sakshi D.	I	
	02-04 Sonali Gorale ✓	Jyoti Hegade	Sonali G.	I	
5	01-03 Anushri Bahekar	Sakshi Deshmukh ✓	Sakshi D.	I	
	05-02 Jinnat Pathan	Sonali Gorale ✓	Sonali G.	I	

1. Sakshi Deshmukh
2. Anushri Bahekar
3. Sonali Gorale

Patil

Jinnat Pathan (Narsing)

*W Patil
16/12/2017
TW.*

*AD Sakpal
PJA*

Mat-3

Jr. girls u/21	40 to 44Kg girls	45th Junior Girls and Boy	Meetai Thakare Stadi	15/12/2017	10 Cmp.
Elimination System with Double Repechage for 9 to 16 Competitors				4 min	Matte

Preliminaries and final

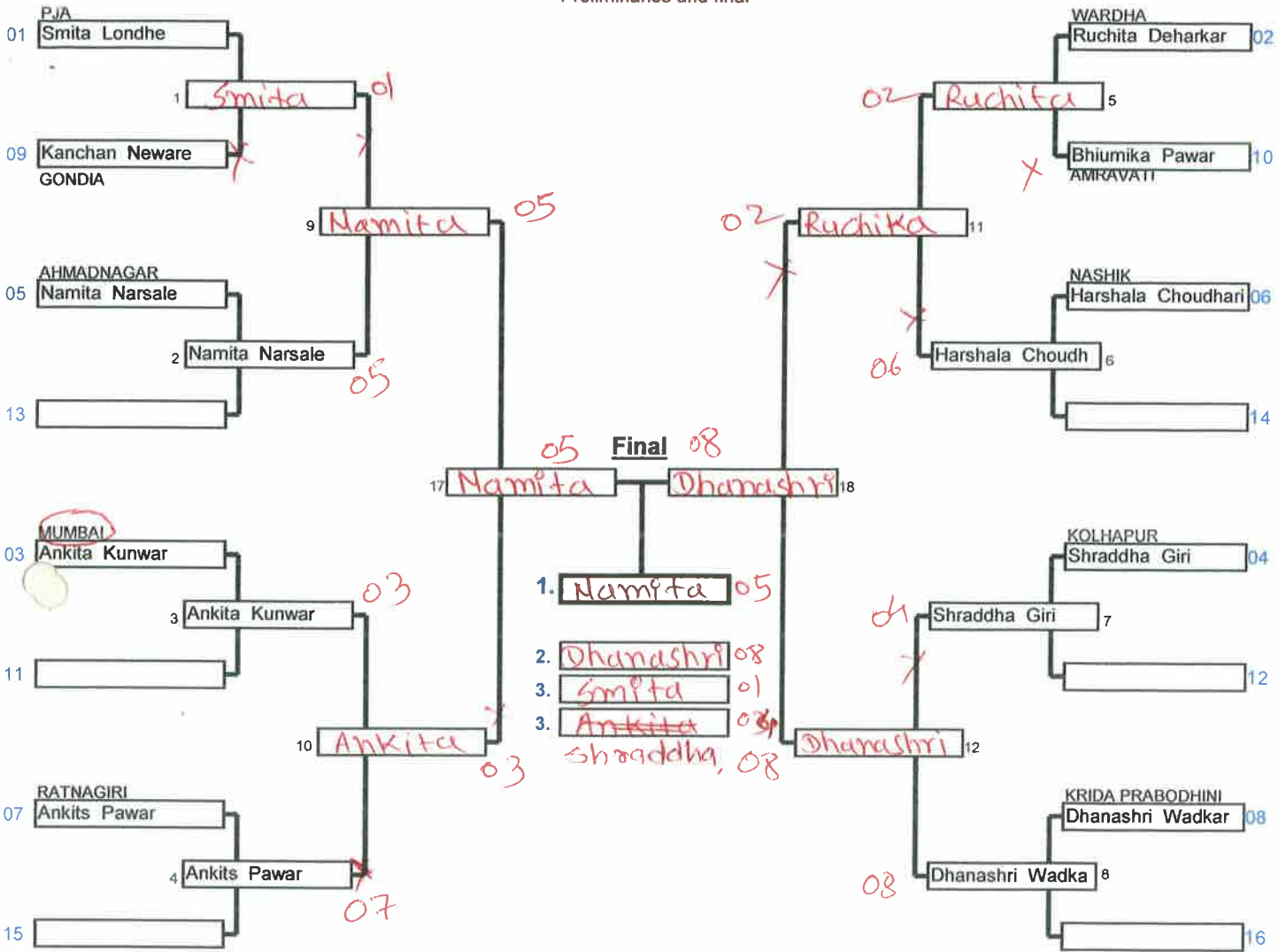

Repechage

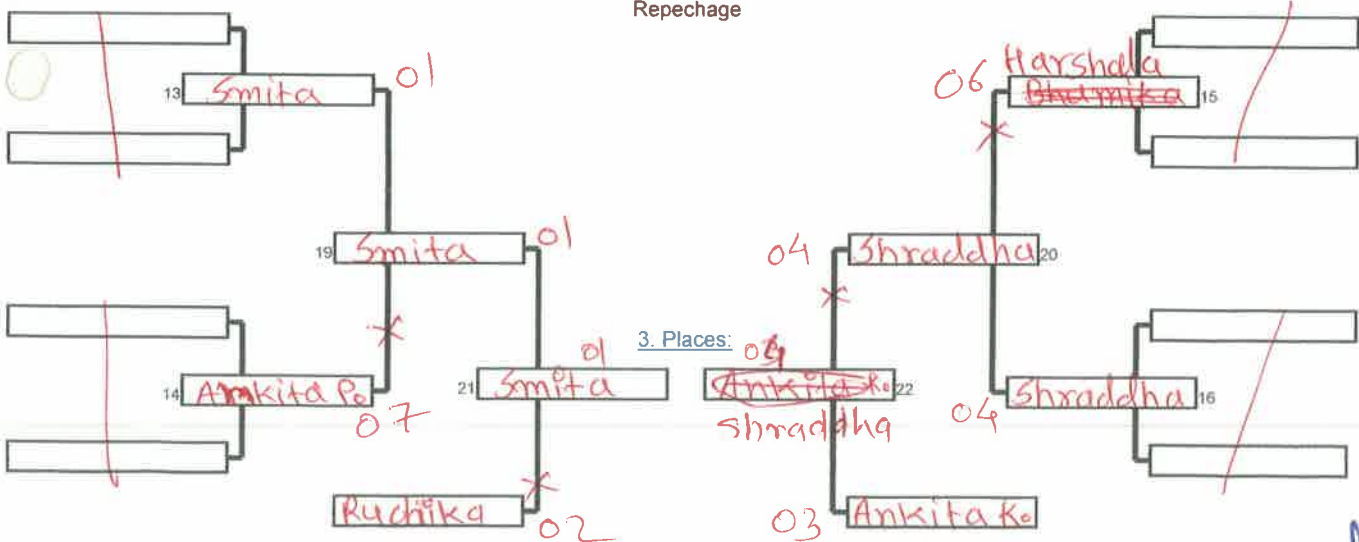

Prakash

Jm (Narsing)

AD Sainpal PJA

Patil
16/12/17
TO

Mat-3

Jr. girls u/21	44 to 48 Kg girls	45th Junior Girls and Boy	Meetai Thakare Stadi	15/12/2017	10 Cmp.
Elimination System with Double Repechage for 9 to 16 Competitors				4 min	Matte

Preliminaries and final



Repechage

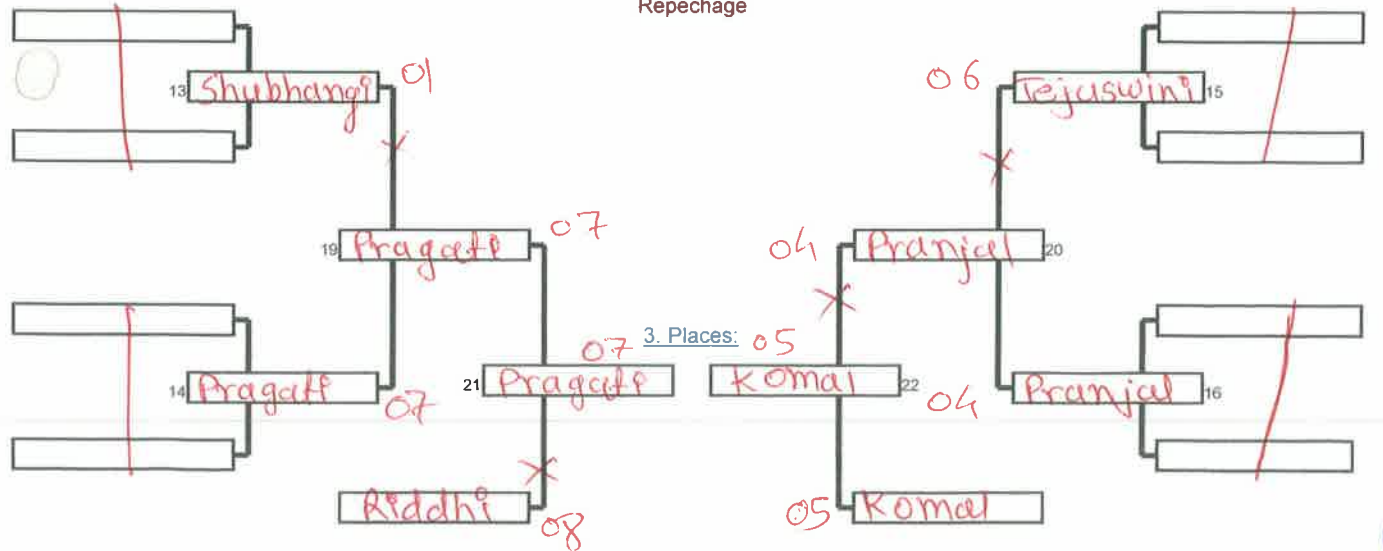

Rohant
 J. Prasad (Crossing)
 B. Patil
 AD. Sakral
 PJA
 16/12/2017
 TRO.

Mat-3

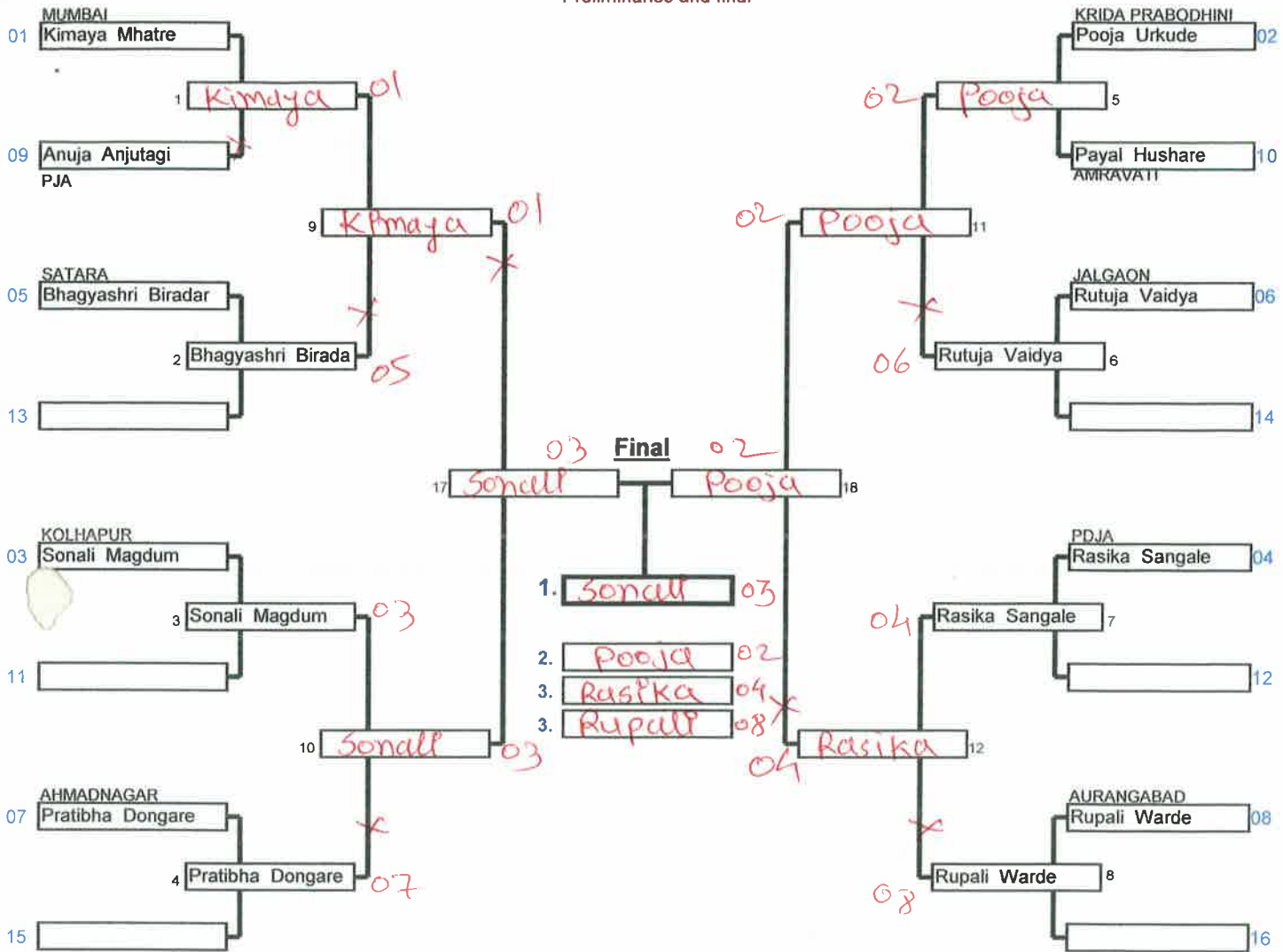

Jr. girls u/21	48 To 52 Kg girls	45th Junior Girls and Boy	Meetai Thakare Stadi	15/12/2017	10 Cmp.
Elimination System with Double Repechage for 9 to 16 Competitors				4 min	Matte

Preliminaries and final

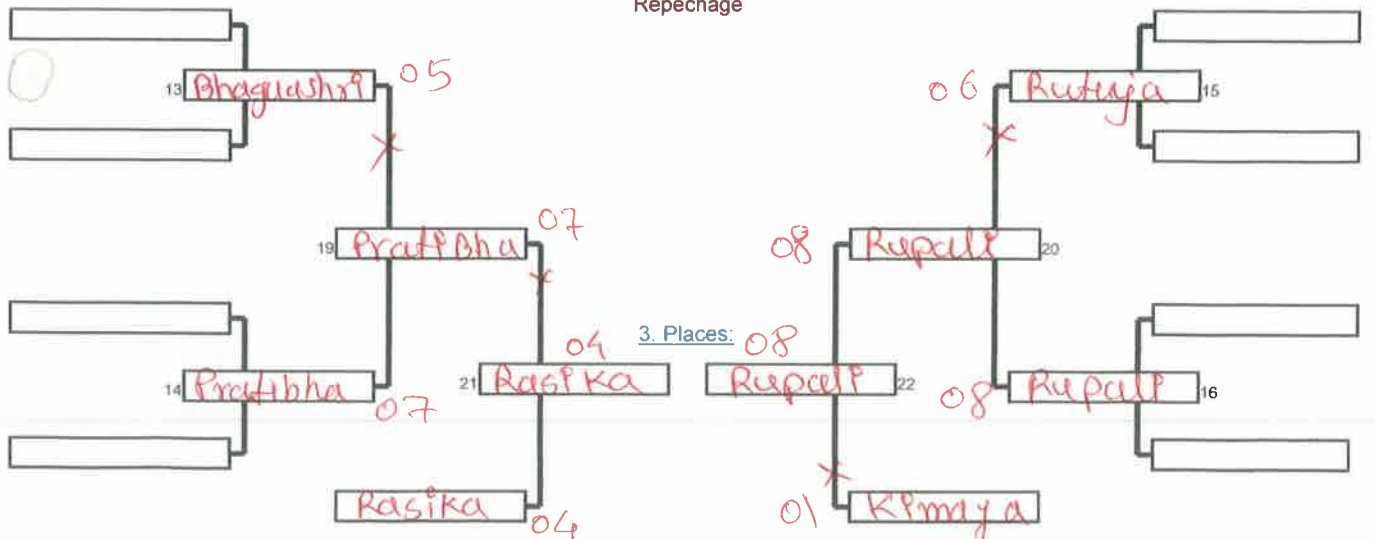

Repechage

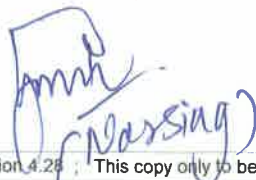

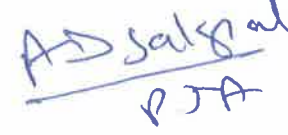
 16/12/17
 T.W.

OK

45th Cadet and Junior State Championship 2017-18, Nashik

MAT NO. 1 1

DATE: 17-Dec-2017

wt. Category	Age Group	Name of the Player	Rank
		Junior Girls	
-57	<u>25/06/1997</u>	MADHURI GHERADE	GOLD
-57	<u>10/09/1999</u>	SHUBHANGI RAUT	SILVER
-57	<u>18/09/1998</u>	DISHA KARKERA	BRONZE
-57	28/07/1998	KOMAL SHID	BRONZE

K-P 05
NAGPUR 48
MUMBAI 94
PJA 95

28/07/1998

wt. Category	Age Group	Name of the Player	Rank
		Junior Girls	
-63	<u>20/2/1997</u>	RUTUJA DONGARE	GOLD
-63	<u>22/11/1999</u>	SAMPADA PHALKE	SILVER
-63	<u>22/03/1997</u>	SHIVANI THATTEKAR	BRONZE
-63	<u>2/12/1998</u>	HEMA MALIYE	BRONZE

PDJA 06
MUMBAI 50
NASHIK 100
AMARAVAI 101

wt. Category	Age Group	Name of the Player	Rank
		Junior Girls	
-70	<u>27/8/1999</u>	TANVIN TAMBOLI	GOLD
-70	<u>19/6/1998</u>	SRISHTTI JENA	SILVER
			BRONZE
			BRONZE

KP 07
MUMBAI 59

wt. Category	Age Group	Name of the Player	Rank
			GOLD
			SILVER
			BRONZE
			BRONZE

Specimen

10/10

B Petil
710

12/12/17

Preliminaries and final

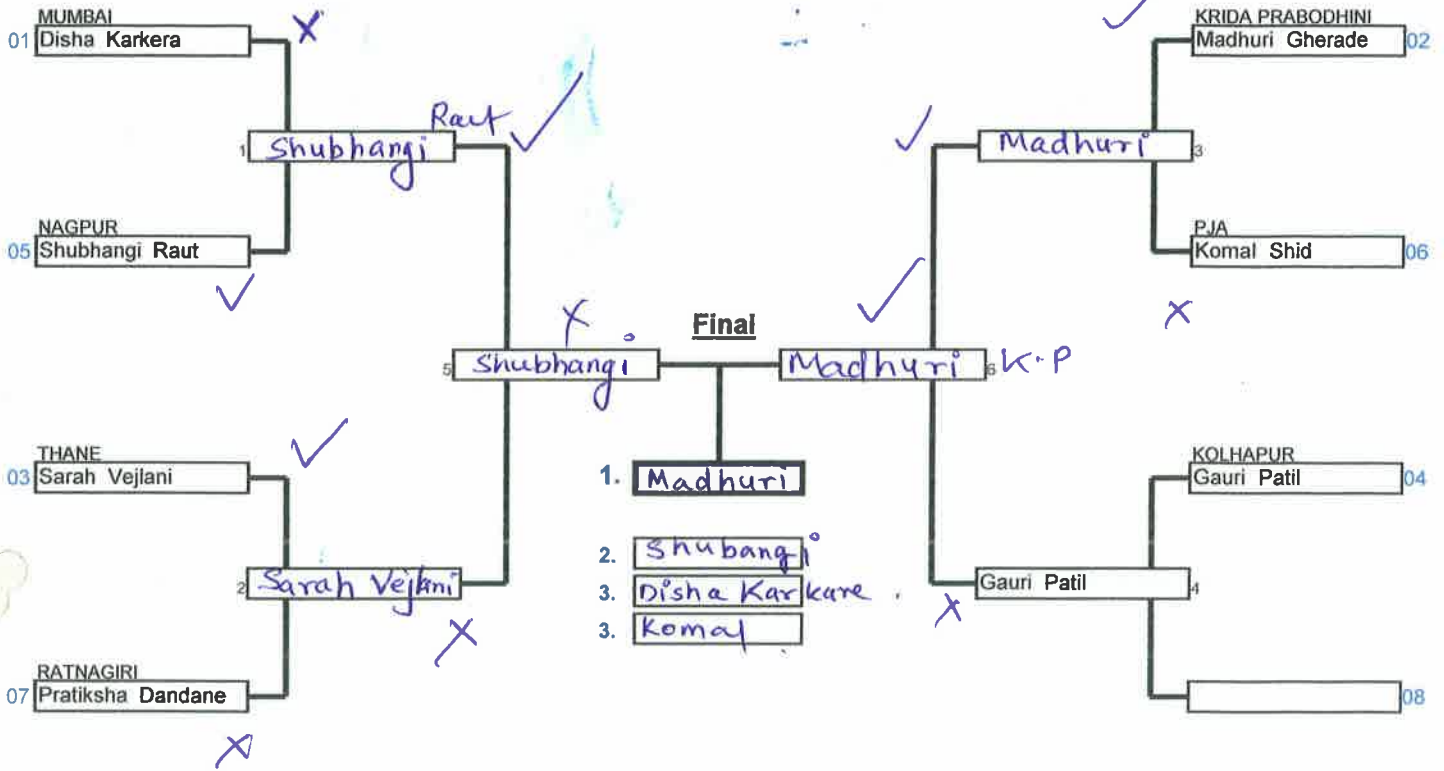

Repechage

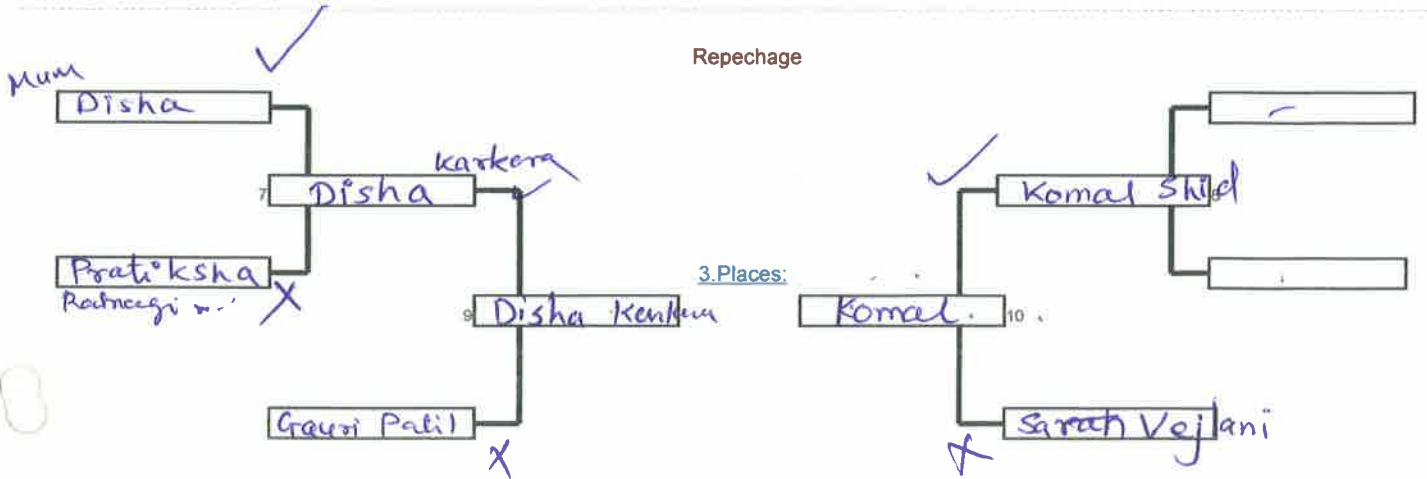

Handwritten signatures and notes:
~~AD~~
AD Kashiy
BPatil
TD

Preliminaries and final

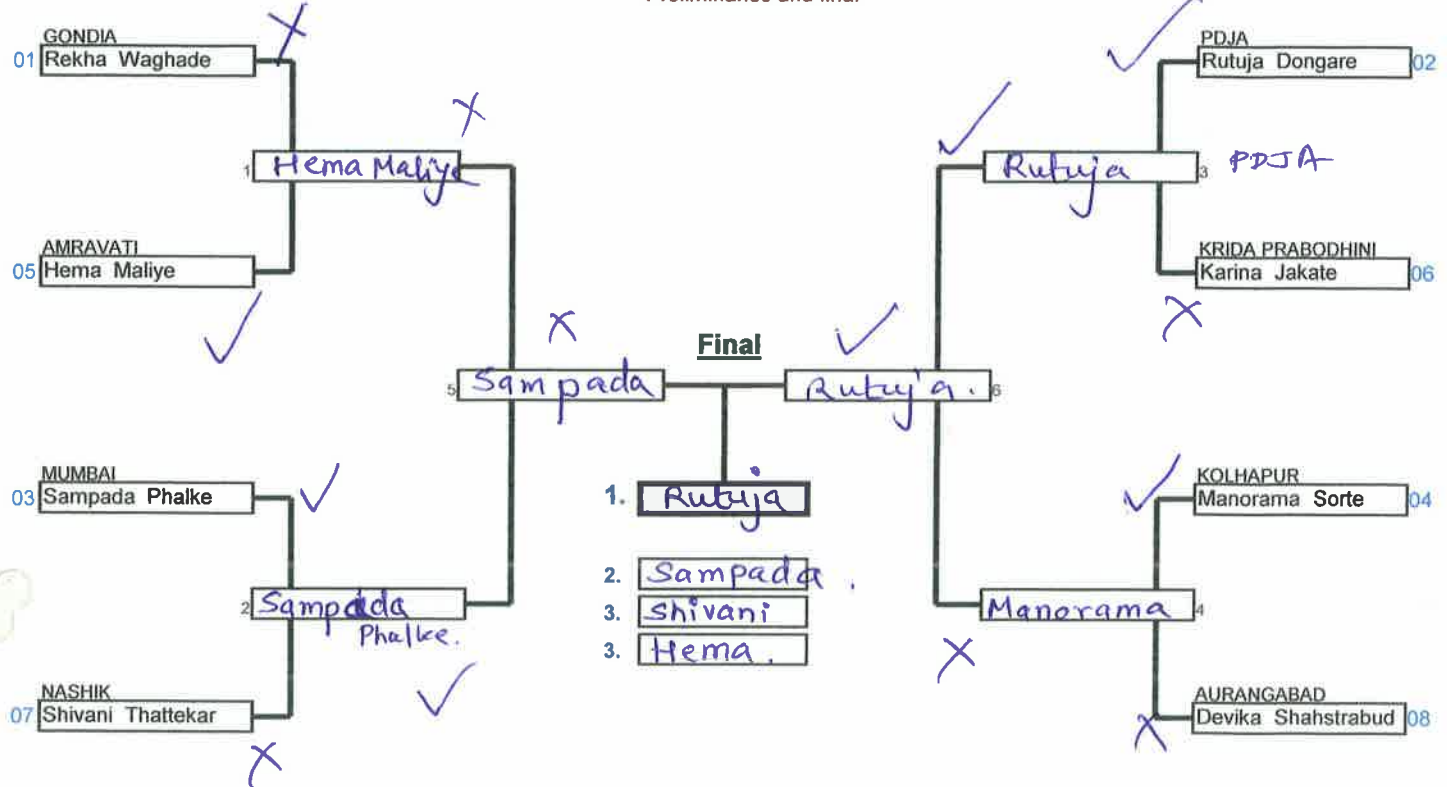

Repechage

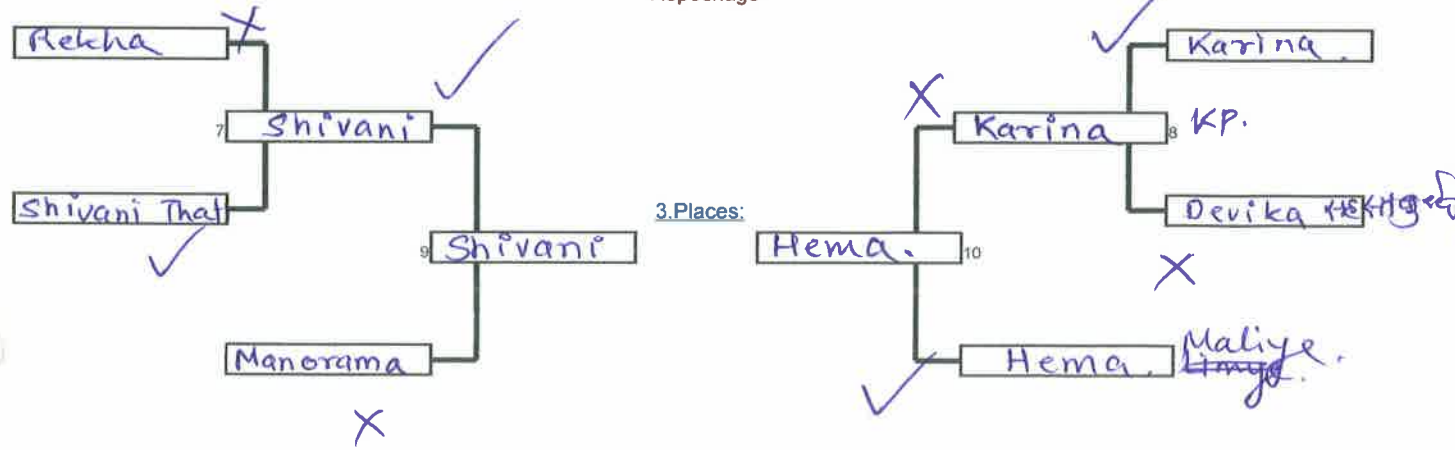

Antar *Deeshid* *BPatil*
TB

Jr. girls u/21	63 To 70 Kg girls	45th Junior Girls and Boy	Meetai Thakare Stadi	15/12/2017	3	Cmp
Round Robin System for 3 Competitors				4 min	Matte	_

Poolk.



Nr. Name	Club	01	02	03	Wins / Pts	Weight	Place
01 Srishti Jena	MUMBAI		0	0	0 0	kg	
02 Tanvin Tamboli	KRIDA PRABODHINI	0		0	0 0	kg	
03 Arti Takale	PDJA	0	0		0 0	kg	

Matches:

Round/Compe	Name ("blue")	Name ("white")	Winner	Pts.	Scores
1 01-02	Srishti Jena X	Tanvin Tamboli ✓	Tanvin		
2 02-03	Tanvin Tamboli ✓	Arti Takale X	Tanvin.		
3 03-01	Arti Takale X	Srishti Jena ✓	Srishti Jena		

1. Tanvin
2. Srishti Jena.
- 3.

TB Pati

TD

Splanone

Av. Ts

Atashid