

SENIOR MEN	+ 100 KG	46th SENIOR STATE ME & NATIONAL TRIAL CHA	DHULE MAHARASHT	22-23/12/2018	13	Cmp.
Elimination System with Double Repechage for 9 to 16 Competitors				4 min	Matte	

Preliminaries and final

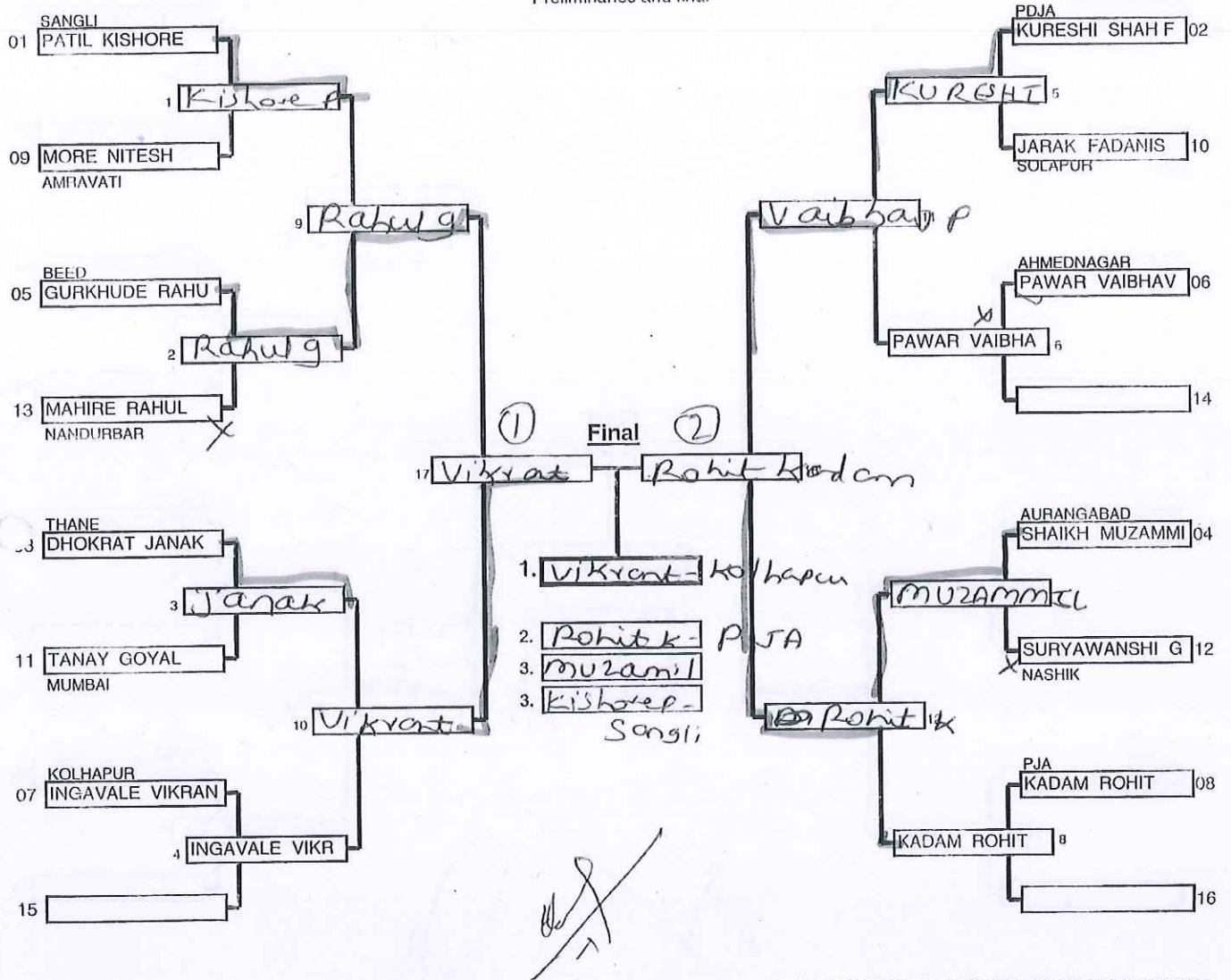

Repechage

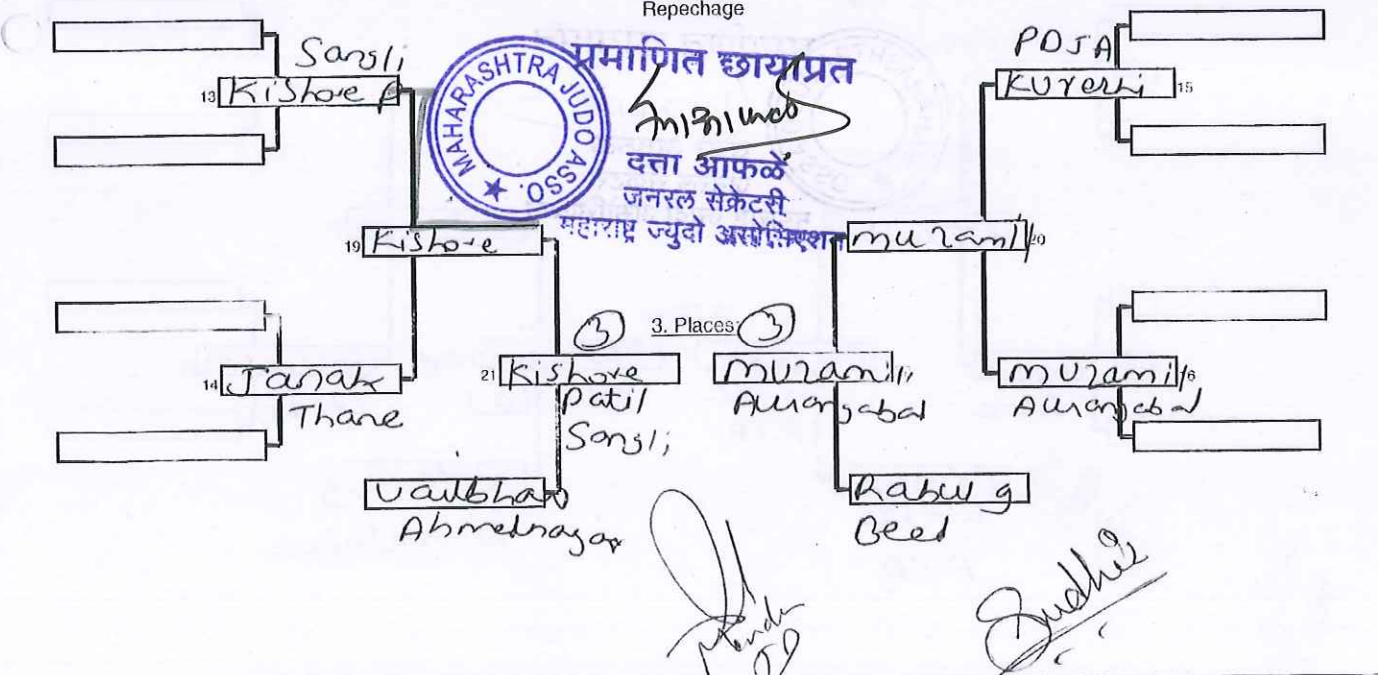

SENIOR MEN	- 100 KG	46th SENIOR STATE ME & NATIONAL TRIAL CHA	DHULE MAHARASHT	22-23/12/2018	10 Cmp.
Elimination System with Double Repechage for 9 to 16 Competitors				4 min	Matte

Preliminaries and final

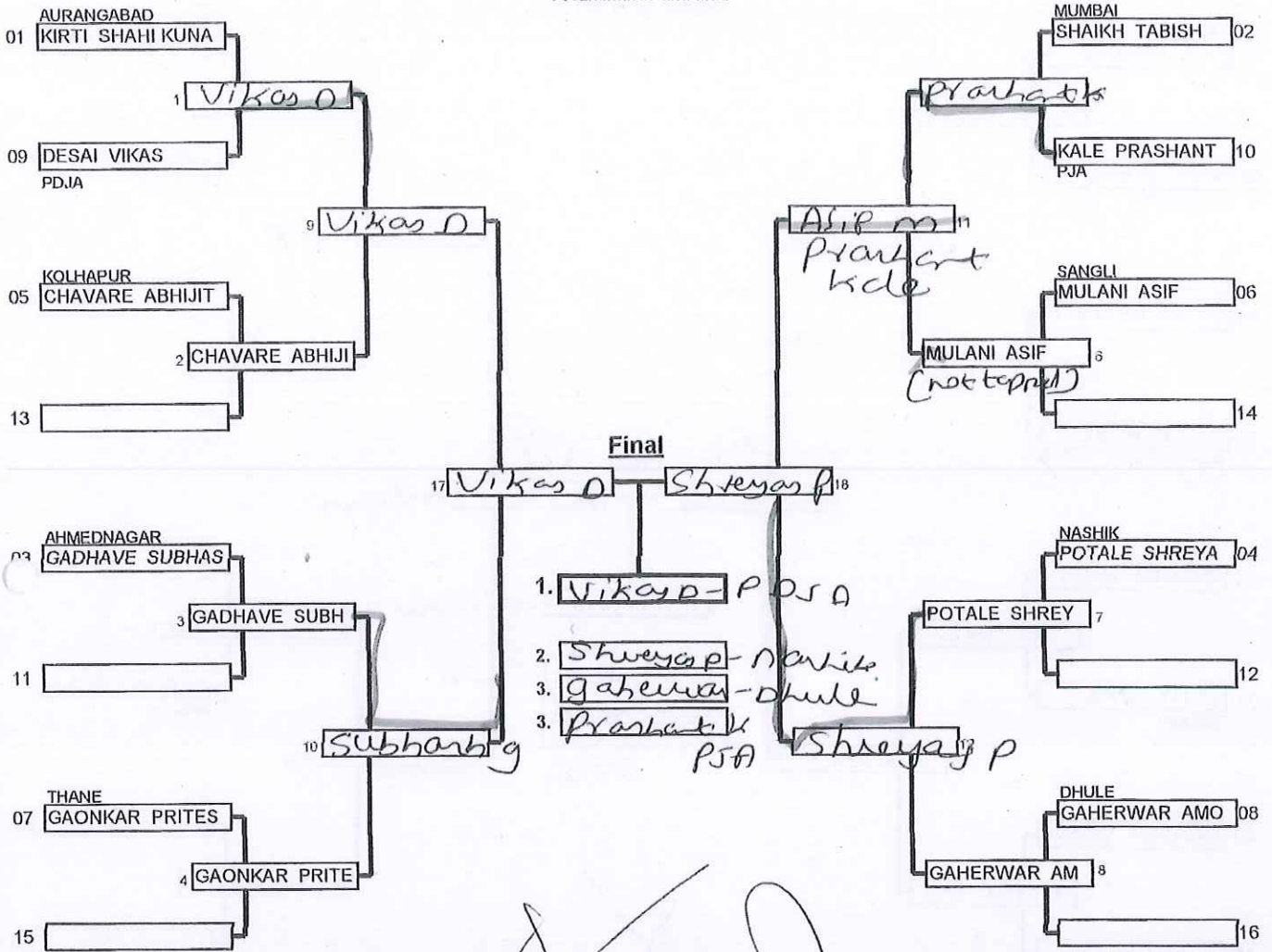

Repechage

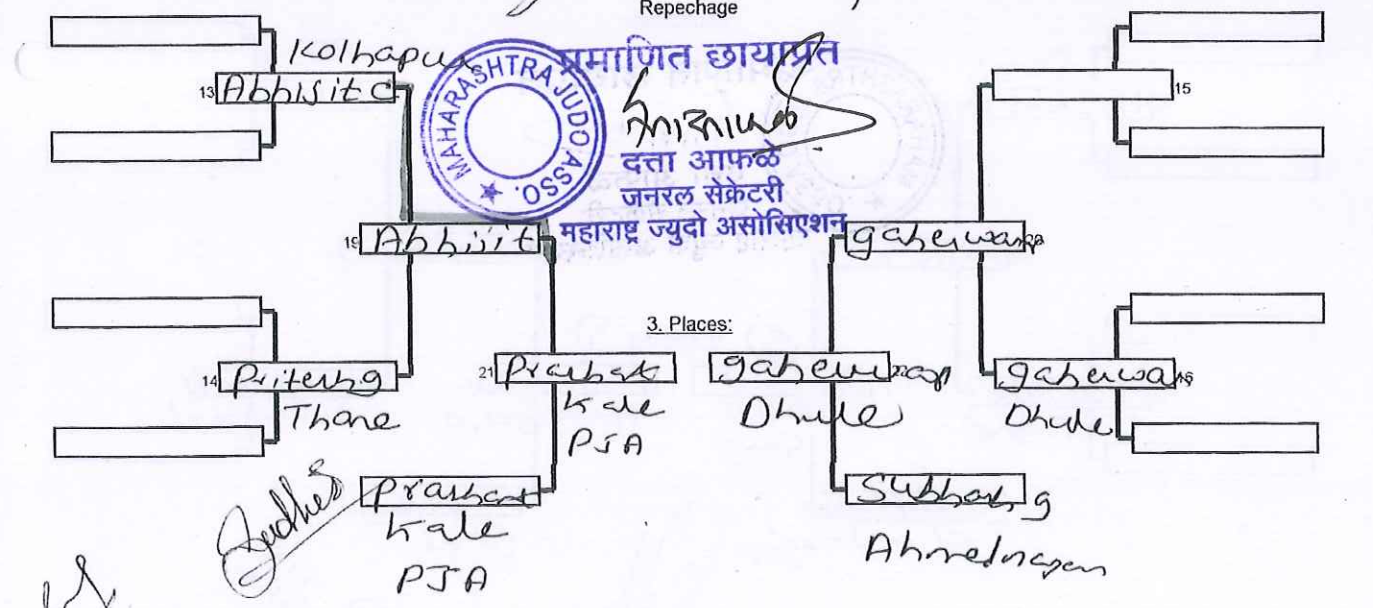

SENIOR MEN	- 90 KG	46th SENIOR STATE ME & NATIONAL TRIAL CHA	DHULE MAHARASH	22-23/12/2018	14	Cmp.
Elimination System with Double Repechage for 9 to 16 Competitors				4 min	Matte	

Preliminaries and final

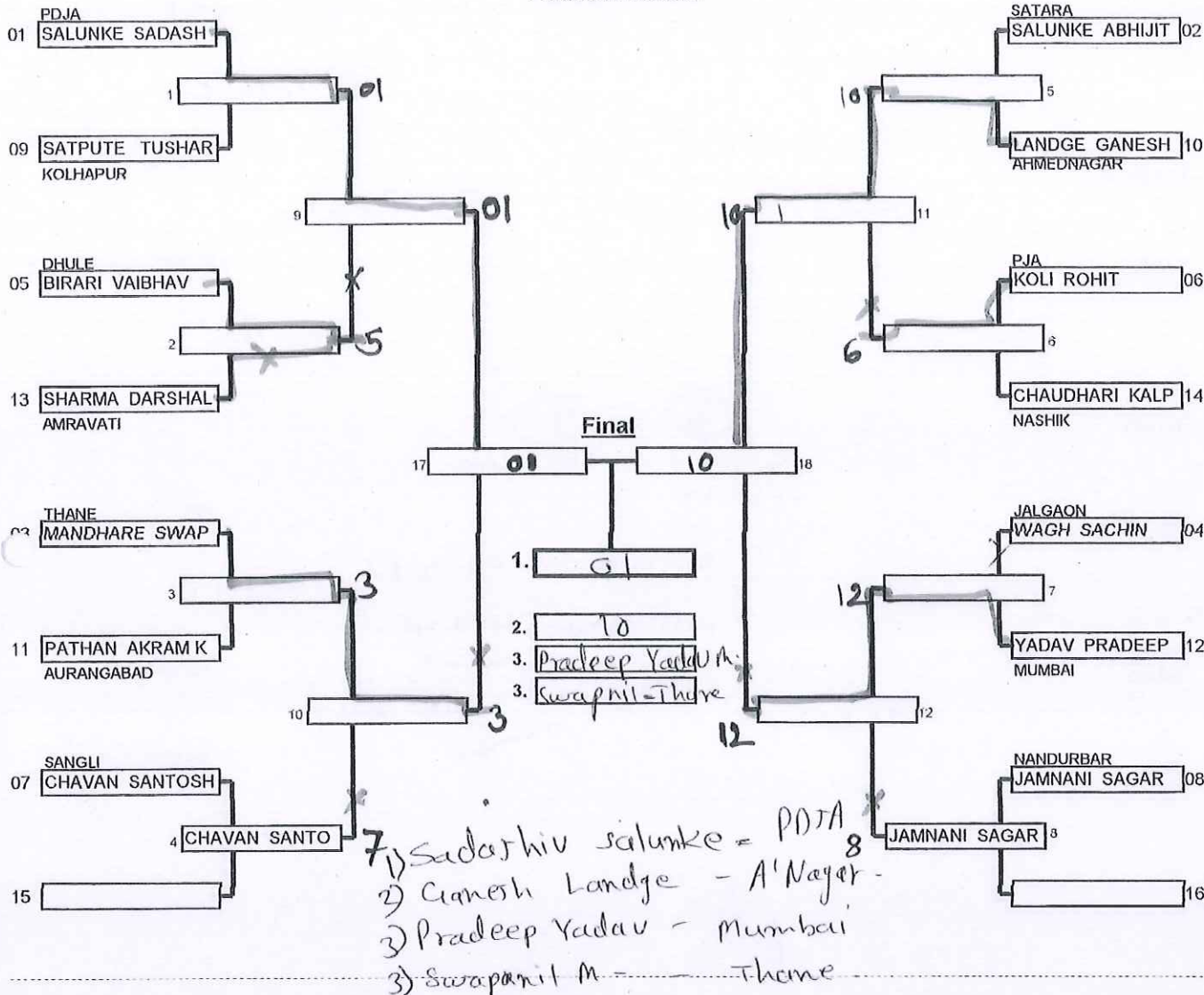

Repechage

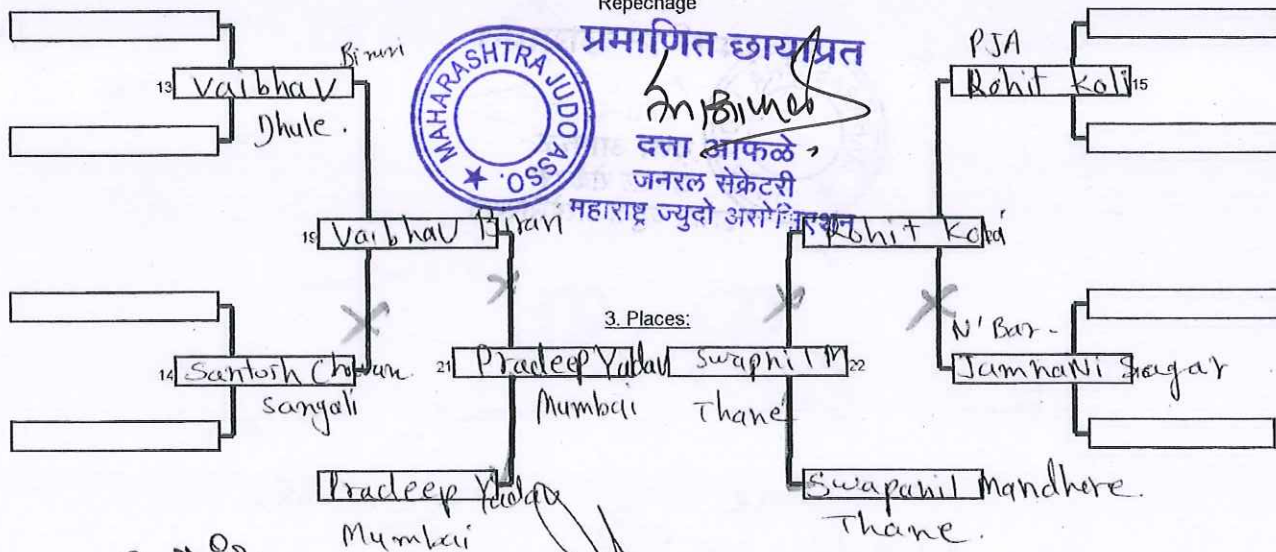

प्रमाणित छायाप्रत

दत्ता भाफळे
 जनरल सेक्रेटरी
 महाराष्ट्र ज्युडो असोसिएशन

Signature

Signature

SENIOR MEN	- 81 KG	46th SENIOR STATE ME & NATIONAL TRIAL CHA	DHULE MAHARASHT	22-23/12/2018	13	Cmp.
Elimination System with Double Repechage for 9 to 16 Competitors				4 min	Matte	

Preliminaries and final

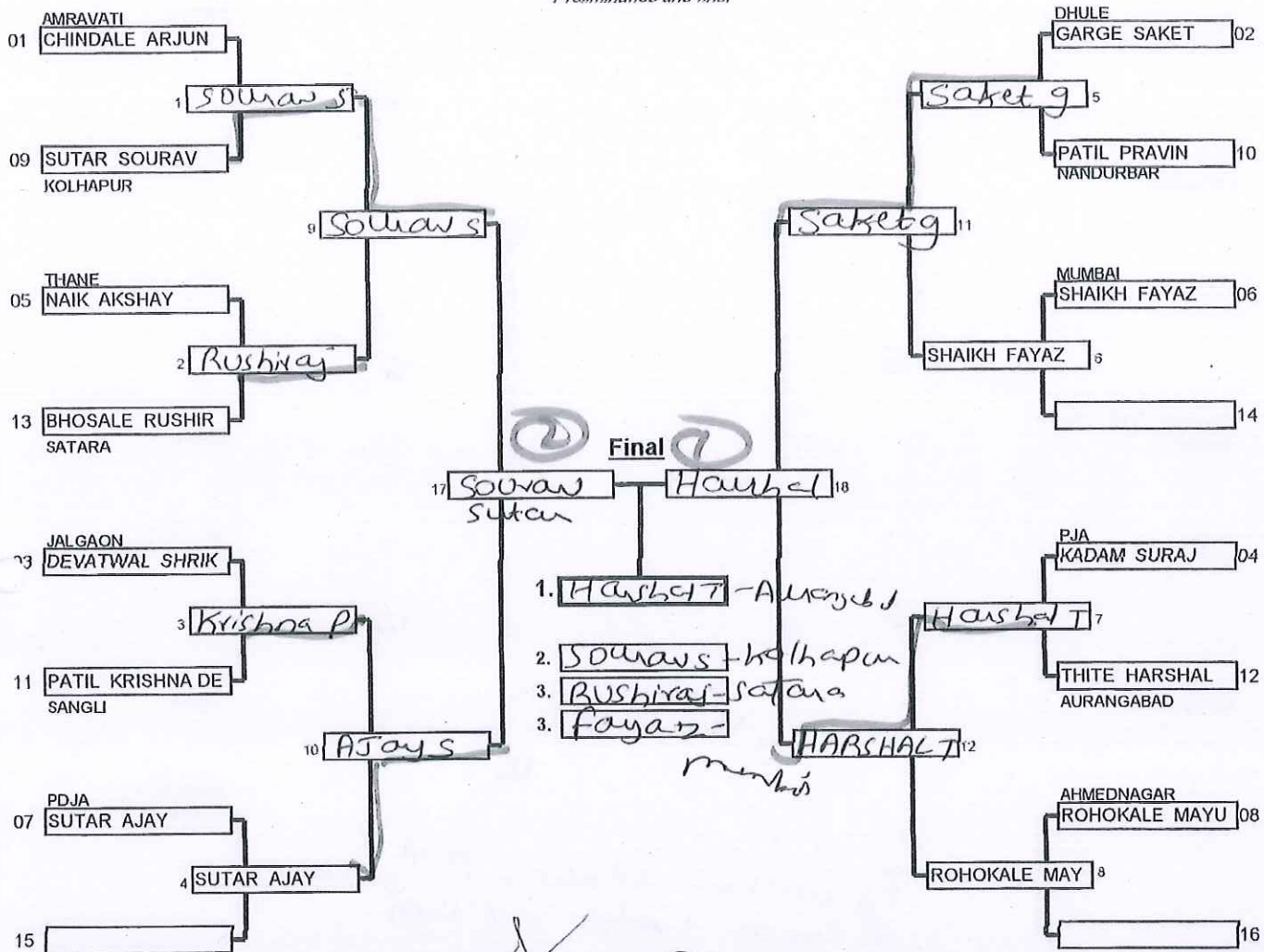

Repechage

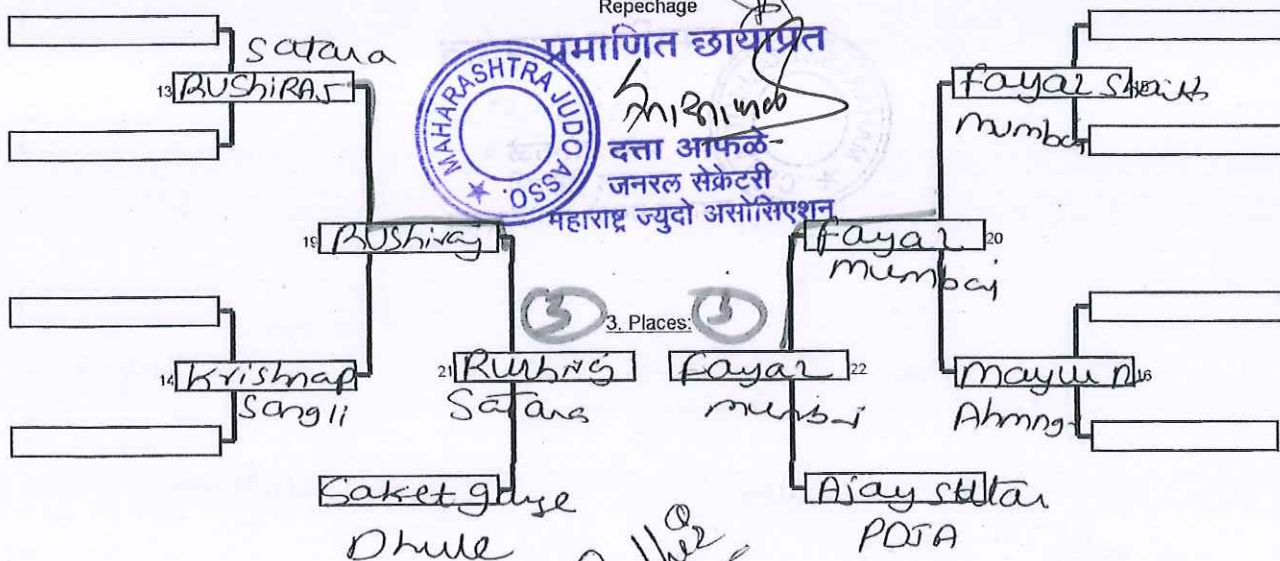

प्रमाणित छायाप्रत
 मिर्जापूर
 दत्ता आफळे -
 जनरल सेक्रेटरी
 महाराष्ट्र ज्युदो असोसिएशन

Dudhe

SENIOR MEN	- 73 KG	46th SENIOR STATE ME & NATIONAL TRIAL CHA	DHULE MAHARASH	22-23/12/2018	16	Cmp.
Elimination System with Double Repechage for 9 to 16 Competitors				4 min	Matte	

Preliminaries and final

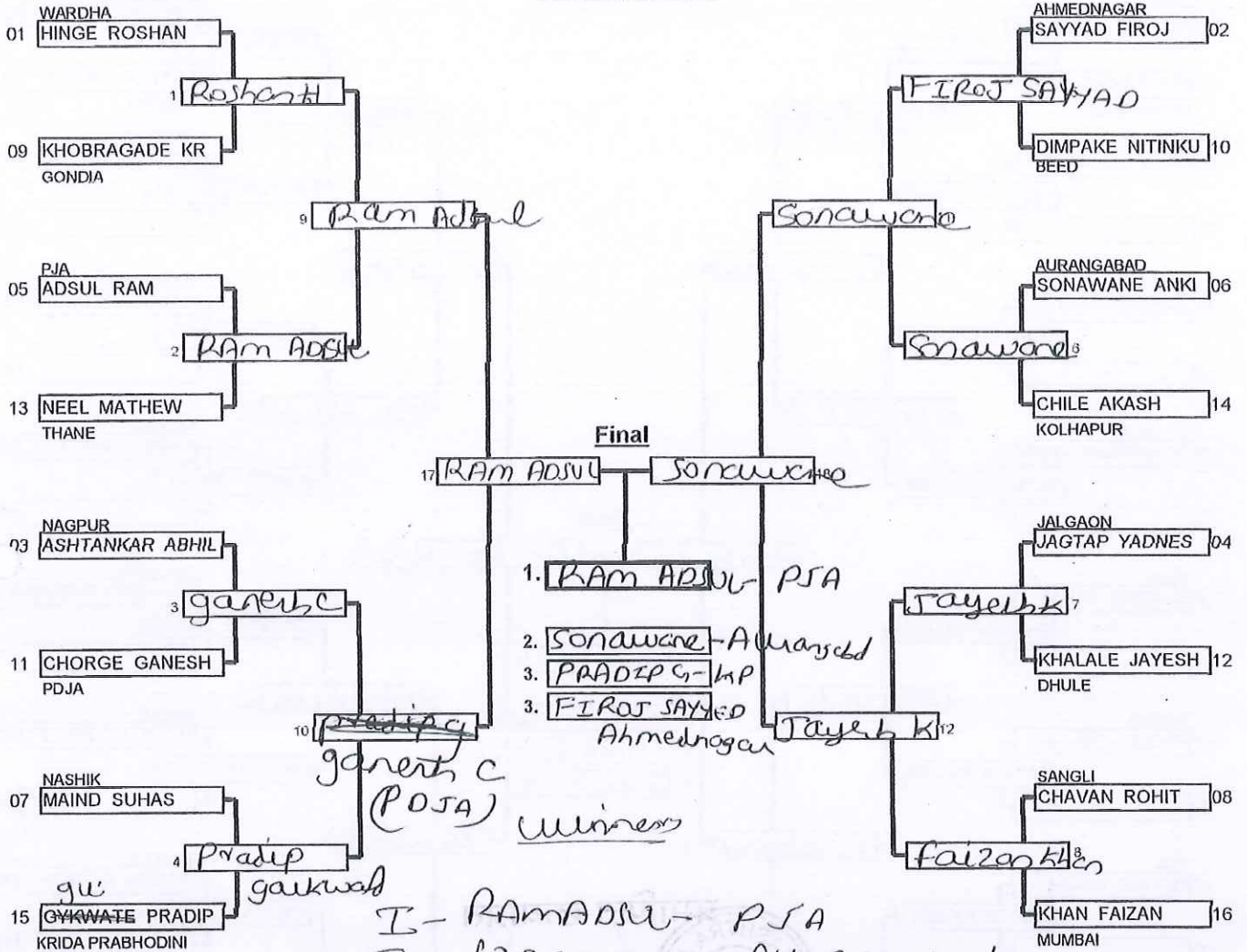

- I - RAM ADSUL - PSA
- II - SONAWANE - Ahmednagar
- III - PRADIP GAIKWAD - KP
- IV - FIROZ SAYYED - Ahmednagar

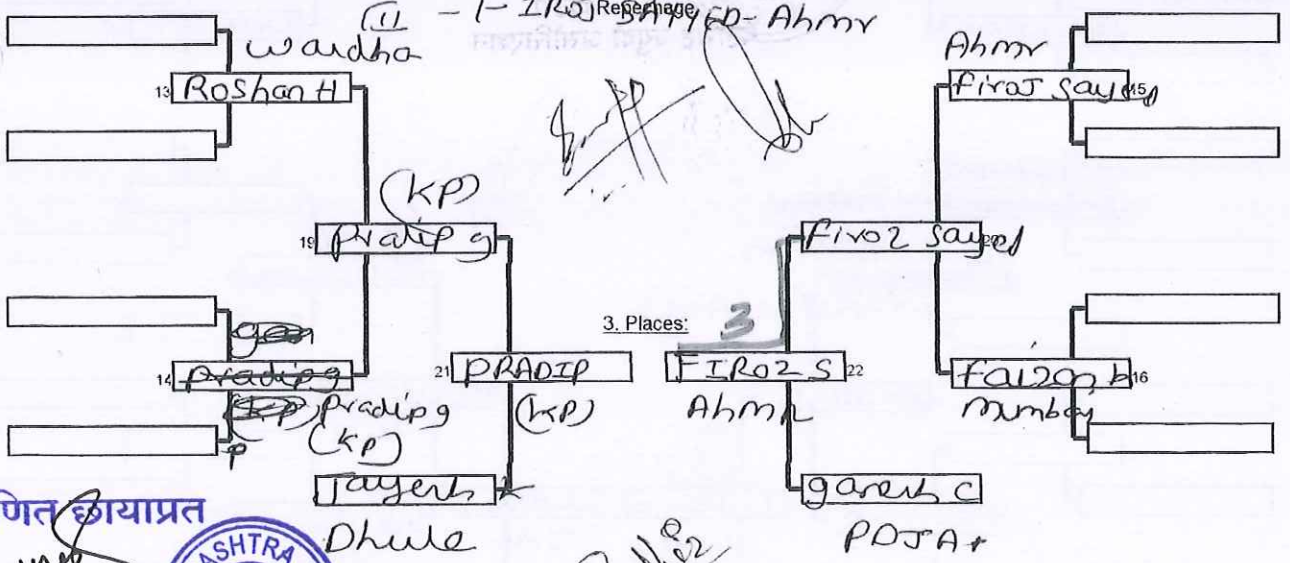

प्रमाणित छायाप्रत

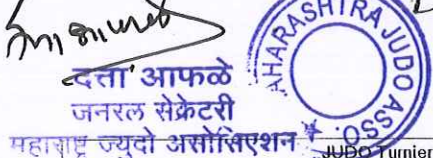

Signature

SENIOR MEN	- 66 KG	46th SENIOR STATE ME & NATIONAL TRIAL CHA	DHULE MAHARASH	22-23/12/2018	18	Cmp.
Elimination System with Double Repechage for 17 to 32 Competitors				4 min	Matte	

Preliminaries and final

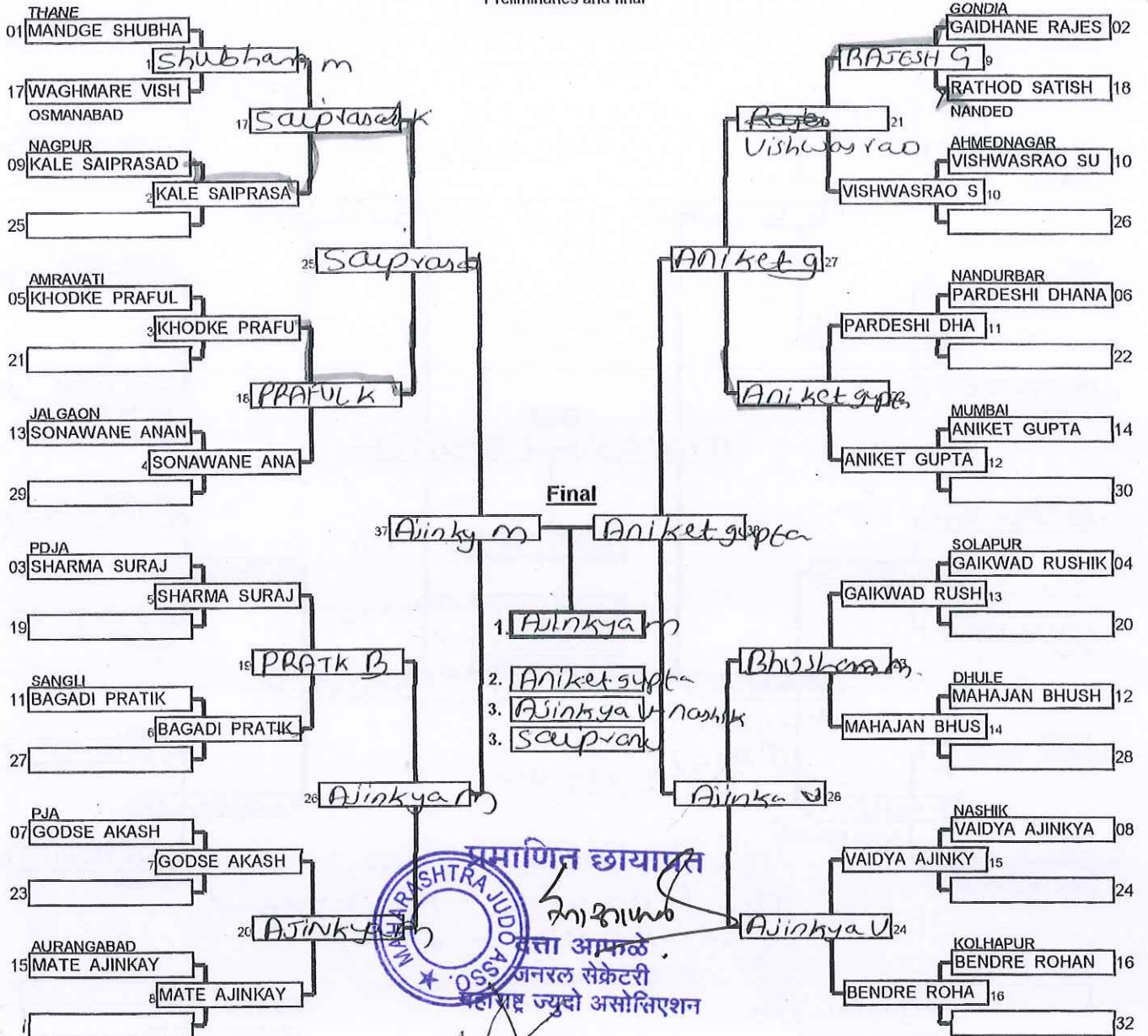

Repechage



SENIOR MEN	- 60 KG	46th SENIOR STATE ME & NATIONAL TRIAL CHA	DHULE MAHARASH	22-23/12/2018	18	Cmp.
Elimination System with Double Repechage for 17 to 32 Competitors				4 min	Matte	

Preliminaries and final

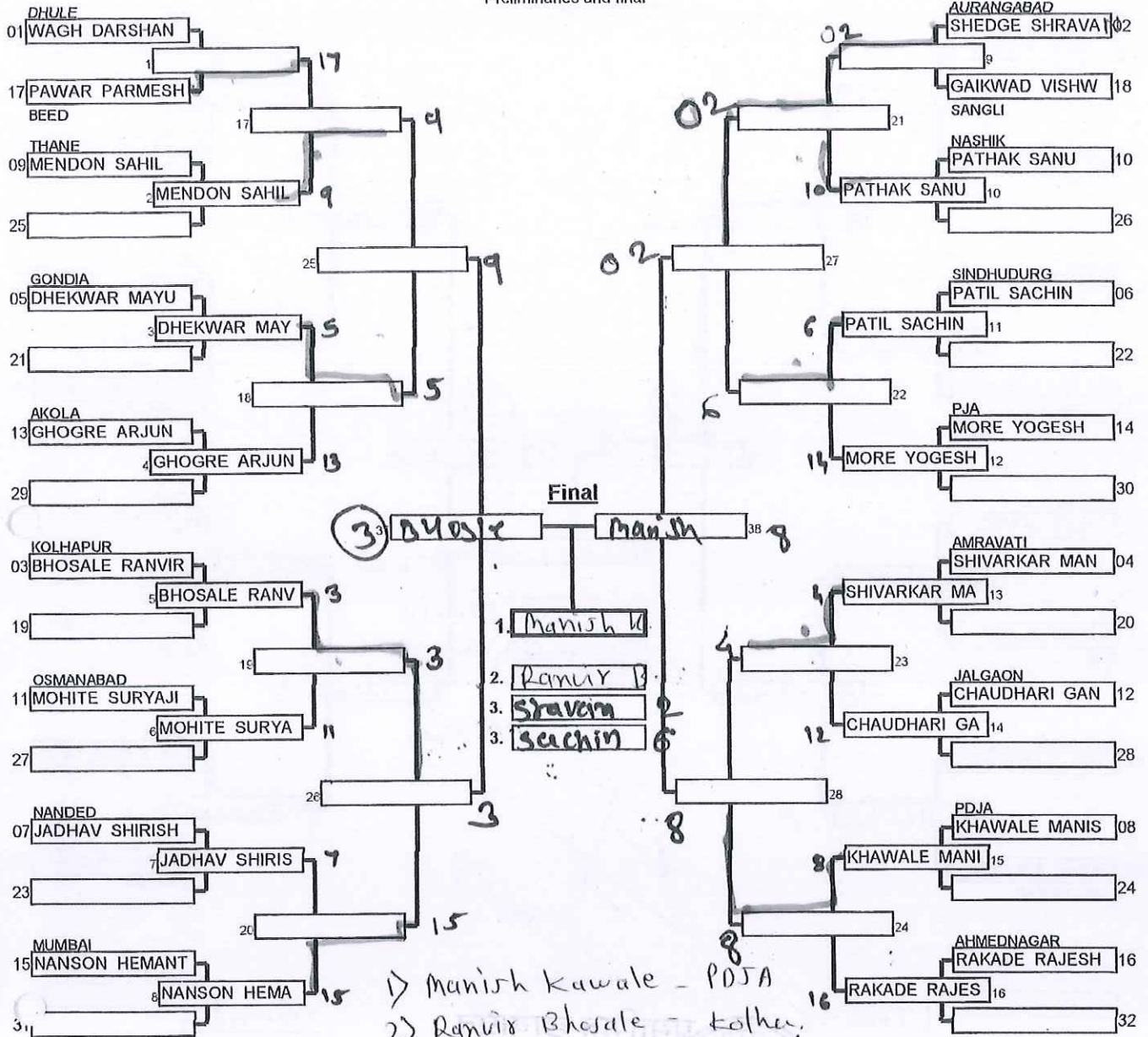

- 1) Manish Kawale - PDJA
- 2) Ranvir Bhosale - Kolhapur
- 3) Shrawan Shedge - A'beed
- 3) Sachi Mendon - Thane
- Sachin Patil - Sindhudurg

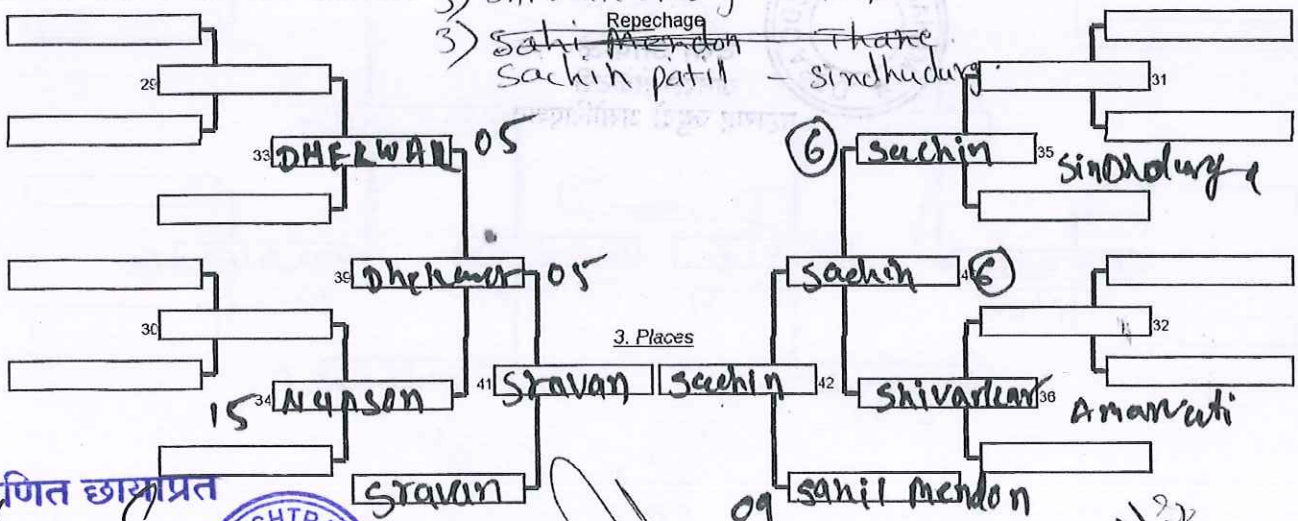

प्रमाणित छायाप्रत

जनरल सेक्रेटरी
महाराष्ट्र ज्युदो असोसिएशन



SENIOR MEN	- 56 KG	46th SENIOR STATE ME & NATIONAL TRIAL CHA	DHULE MAHARASHTR	22-23/12/2018	16	Cmp.
Elimination System with Double Repechage for 9 to 16 Competitors				4 min	Matte	

Preliminaries and final

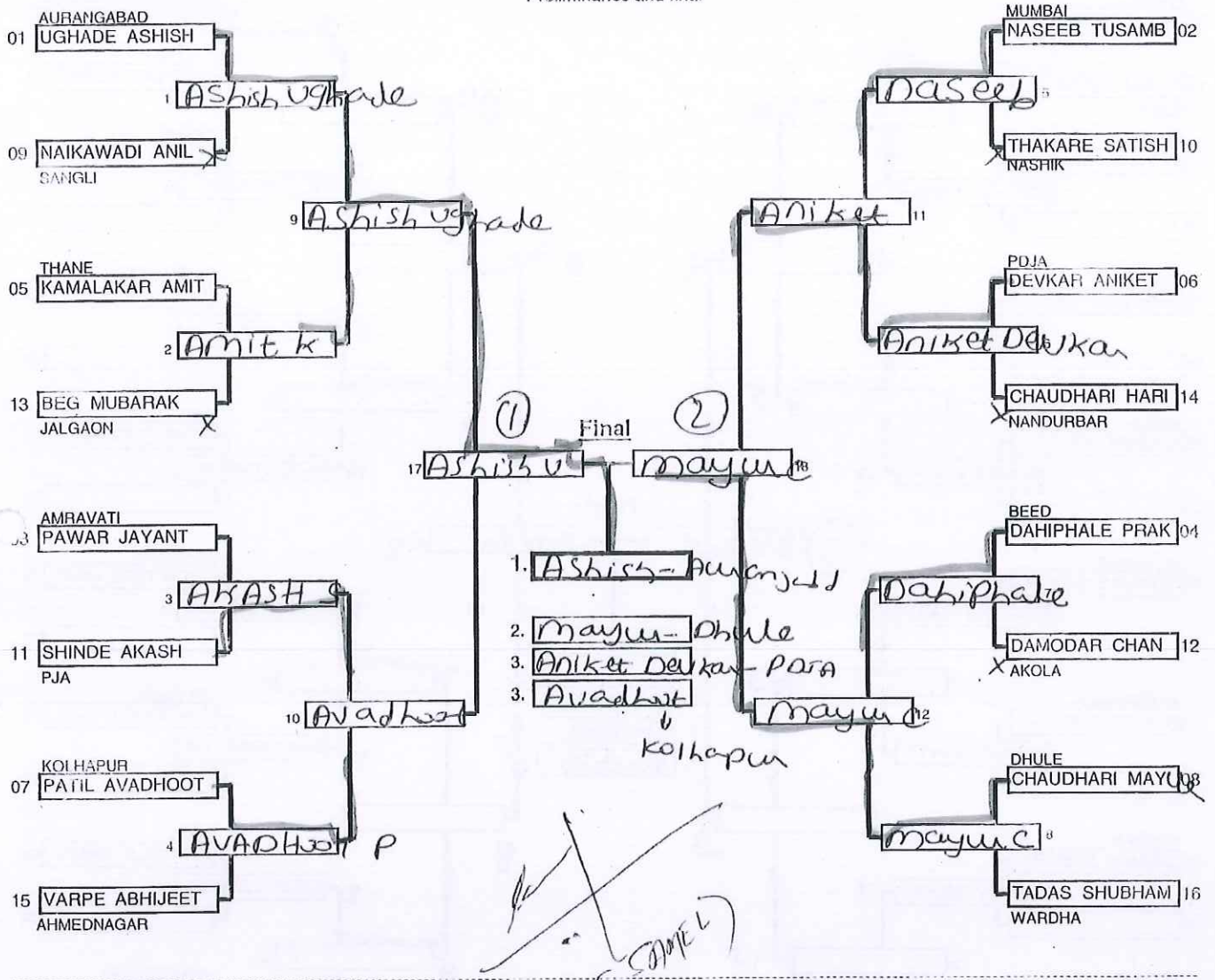

Repechage

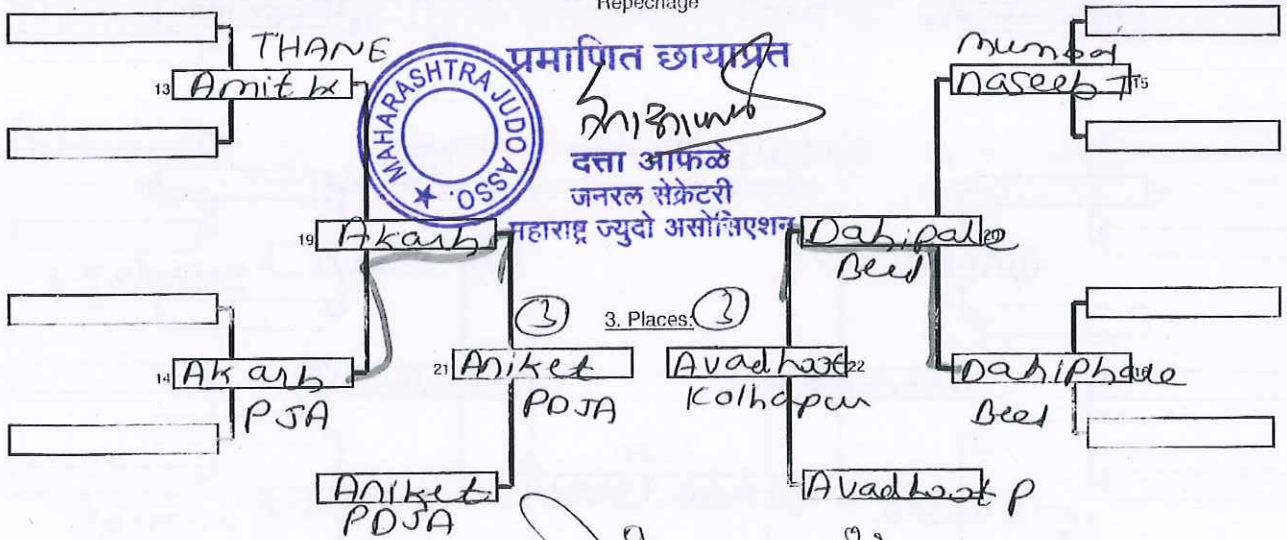

SENIOR WOMEN	+ 78 KG	46th SENIOR STATE ME & NATIONAL TRIAL CHA	DHULE MAHARASH	22-23/12/2018	4	Cmp
Round Robin System for 4 Competitors				4 min	Matte _	

Poolk.

Nr. Name	Club	01	02	03	04	Wins / Pts	Weight	Place
01 SHETTY MAYURI	MUMBAI	0	00	00	0	0 0	kg	
02 PAWAR PRATIKSHA A	SATARA	10	1	0	0	0 0	kg	
03 PATIL APOORVA	THANE	0	0	10		0 0	kg	
04 SAINI GURPREETKAUR	DHULE	0	0	00		0 0	kg	

Matches:

Round/Comp	Name ("white")	Name ("blue")	Winner	Pts.	Scores
1 01-02	SHETTY MAYURI	PAWAR PRATIKSH	Blue	10	Ippon (a.s.)
03-04	PATIL APOORVA	SAINI GURPREETK	White	00	Ippon (wasakomi) 37 sec.
2 03-01	PATIL APOORVA	SHETTY MAYURI	white	001	Ippon (wasakomi) 37 sec.
04-02	SAINI GURPREETK	PAWAR PRATIKSHA	white		2w (a.s.) 52 sec.
3 01-04	SHETTY MAYURI	SAINI GURPREETK	white		2w Ippon (osakomi) 0.50
02-03	PAWAR PRATIKSH	PATIL APOORVA	Blue		Ippon (1-27)

1. Apoorva Patil (Thane)
2. Pratiksha Pawar (Satara)
3. Mayuri Shetty (Mumbai)
4. Gurspreetkaur Saini (Dhule)



प्रमाणित छायाप्रत

M. J. J. J.
 दत्ता आफलें
 जनरल सेक्रेटरी
 महाराष्ट्र ज्युदो असोसिएशन

Hendon
 TD

Dhule



SENIOR WOMEN	- 78 KG	46th SENIOR STATE ME & NATIONAL TRIAL CHA	DHULE MAHARASHT	22-23/12/2018	4	Cmp
Round Robin System for 4 Competitors				4 min	Matte	

Poolk.

Nr. Name	Club	01	02	03	04	Wins / Pts	Weight	Place
01 GAONKAR HIMANI	THANE		00	00	00	0 0	kg	
02 SHIRSAT SUREKHA	AHMEDNAGAR	10		10	10	0 0	kg	I
03 BAKODE SAPANA R	AMRAVATI	10	00		00	0 0	kg	III
04 PHATERPEKAR POOJA	MUMBAI	10	00	10		0 0	kg	II

Matches:

Round/Compe	Name ("white")	Name ("blue")	Winner	Pts.	Scores
1	01-02 GAONKAR HIMANI	SHIRSAT SUREKH	Surekha	2w	1 min.
	03-04 BAKODE SAPANA	PHATERPEKAR PO	Pooja	2w	28 sec.
2	03-01 BAKODE SAPANA	GAONKAR HIMANI	sapana	I	3:06 min
	04-02 PHATERPEKAR PO	SHIRSAT SUREKH	Surekha	2w	2:33
3	01-04 GAONKAR HIMANI	PHATERPEKAR PO	Pooja	Bye.	
	02-03 SHIRSAT SUREKH	BAKODE SAPANA	Surekha	2w	2:00

- 1.
- 2.
- 3.

1) Surekha shirsath - A' Nagar I
 2) Pooja Phaterpekar - Mumbai II
 3) sapana Bakode - A'vati III



प्रमाणित छायाप्रत

दत्ता अफळे
 जनरल सेक्रेटरी
 महाराष्ट्र ज्युदो असोसिएशन

(Handwritten signatures)



SENIOR WOMEN	- 70 KG	46th SENIOR STATE ME & NATIONAL TRIAL CHA	DHULE MAHARASHT	22-23/12/2018	6	Cmp.
Elimination System with Double Repechage for up to 8 Competitors				4 min	Matte	

Preliminaries and final

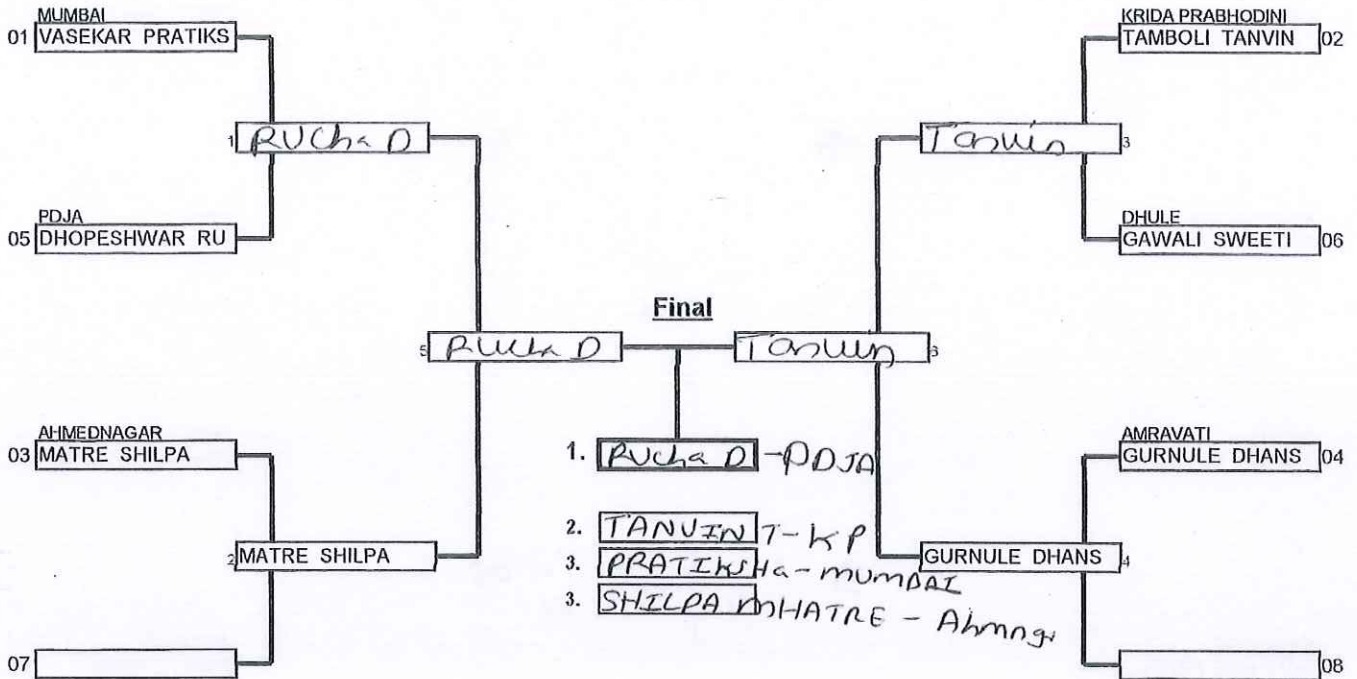

Repechage

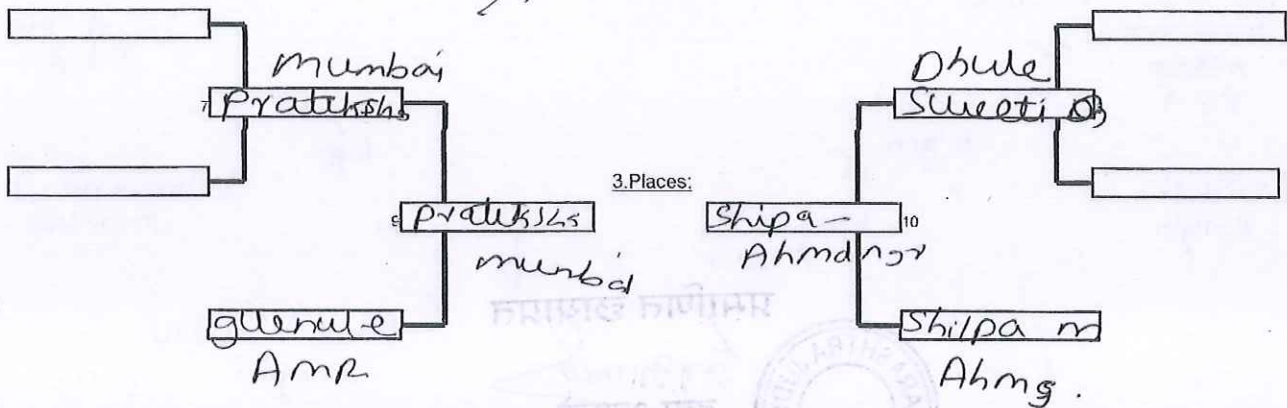

प्रमाणित छायाप्रत
 दत्ता आफळे
 जनरल सेक्रेटरी
 महाराष्ट्र ज्युदो असोसिएशन

SENIOR WOMEN	- 63 KG	46th SENIOR STATE ME & NATIONAL TRIAL CHA	DHULE MAHARASH	22-23/12/2018	8	Cmp.
Elimination System with Double Repechage for up to 8 Competitors				4 min	Matte	

Preliminaries and final

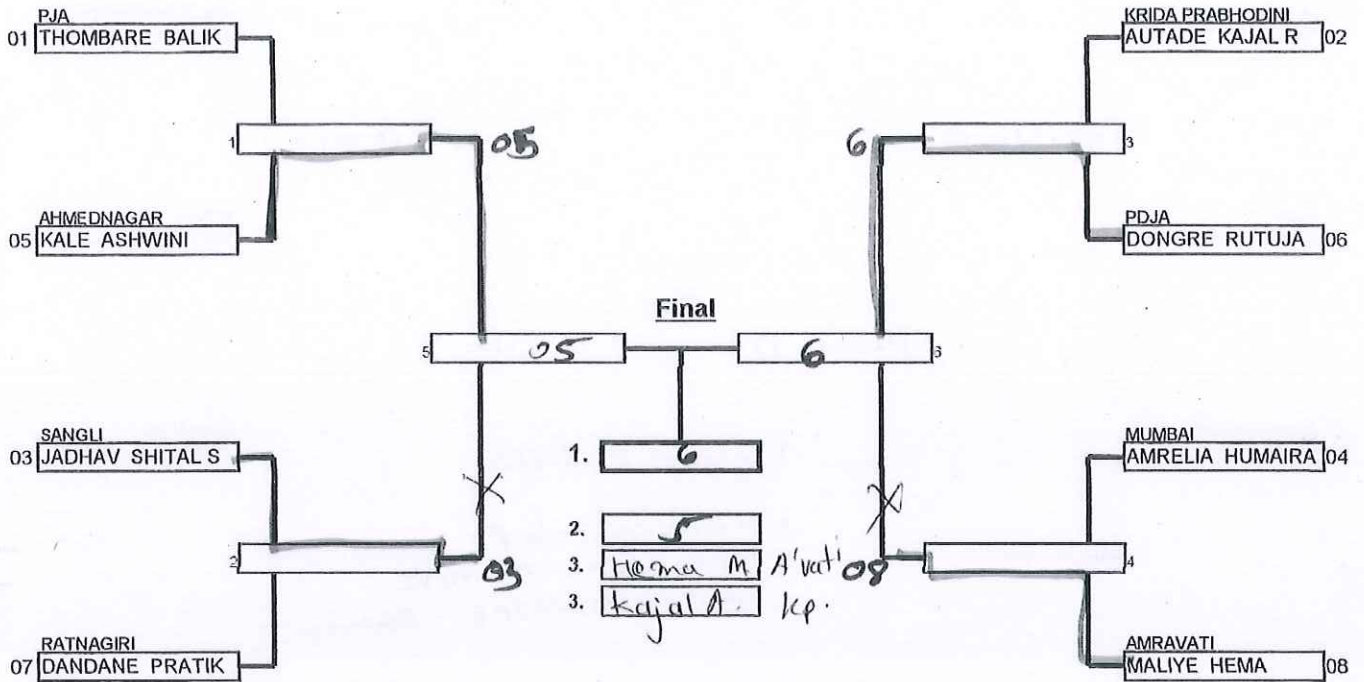

Repechage

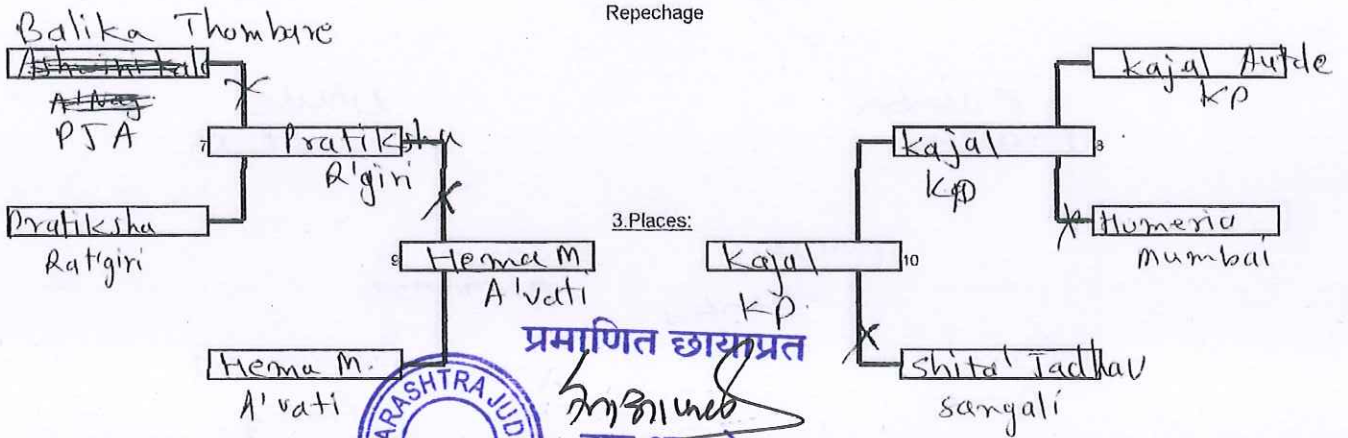

- 1) Rutuja Dongre - PDJA
- 2) Ashwini Kale - A' Nagar
- 3) Hema Maliye - A'vati
- 3) Kajal Autade - Kp

[Handwritten signature]

SENIOR WOMEN	- 57 KG	46th SENIOR STATE ME & NATIONAL TRIAL CHA	DHULE MAHARASHT	22-23/12/2018	9 Cmp.
Elimination System with Double Repechage for 9 to 16 Competitors				4 min	Matte

Preliminaries and final

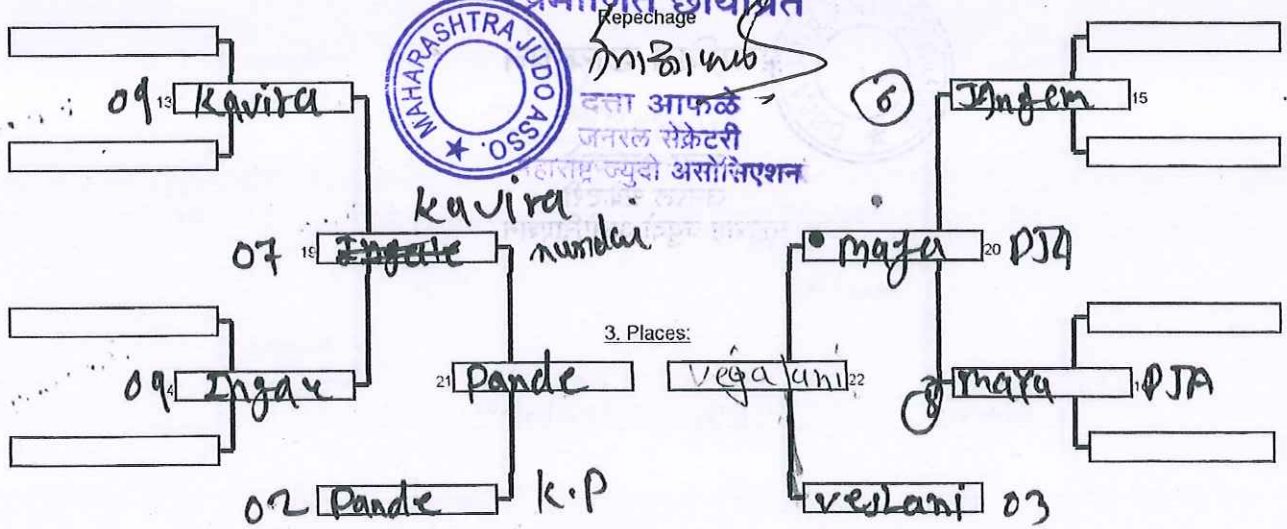
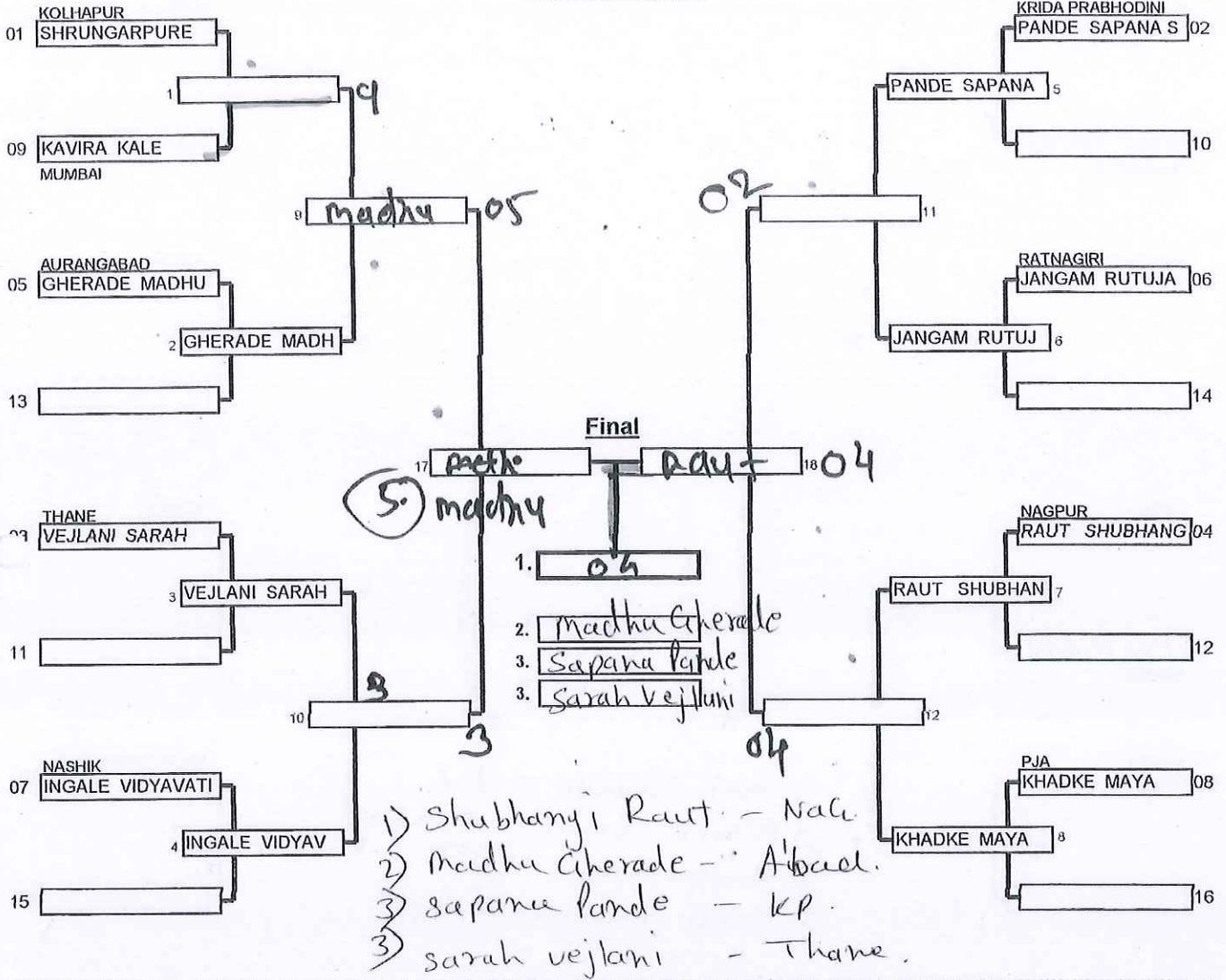

(Handwritten signatures and marks)

Preliminaries and final

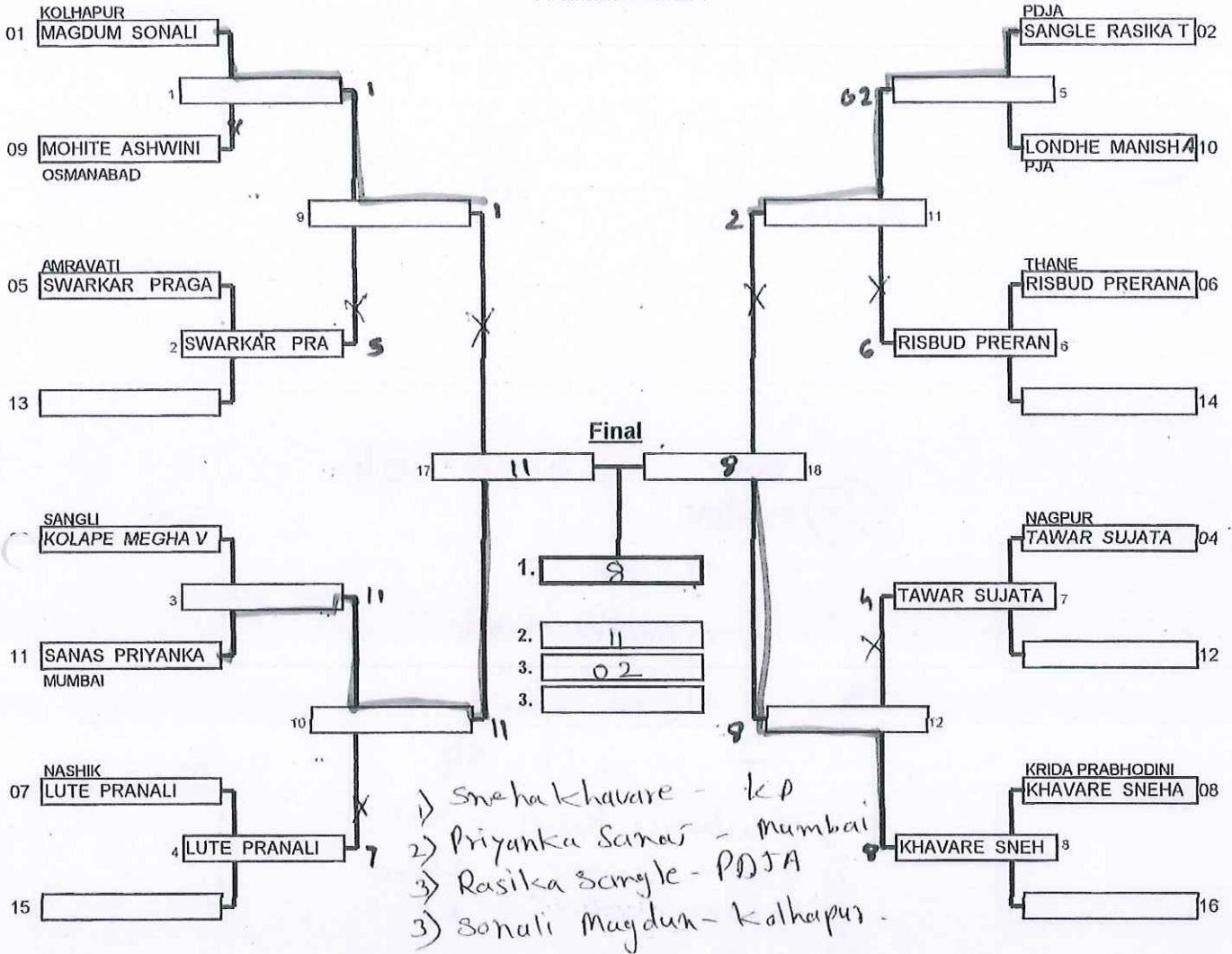

Repechage

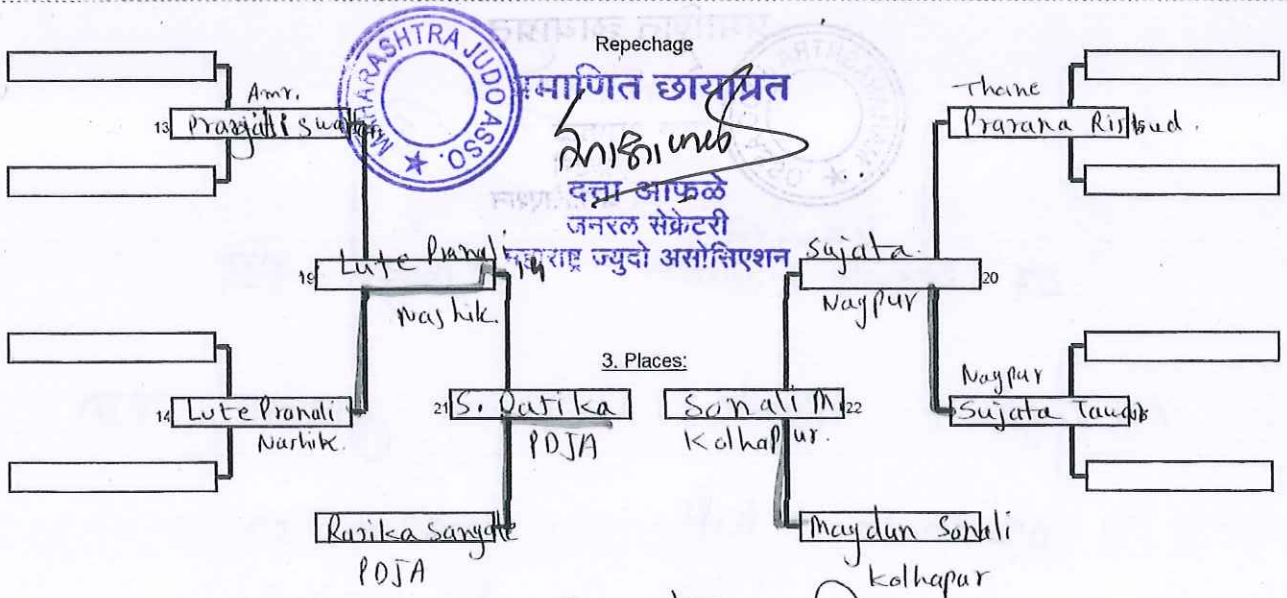

SENIOR WOMEN	- 48 KG	46th SENIOR STATE ME & NATIONAL TRIAL CHA	DHULE MAHARASHT	22-23/12/2018	10 Cmp.
Elimination System with Double Repechage for 9 to 16 Competitors				4 min	Matte

Preliminaries and final

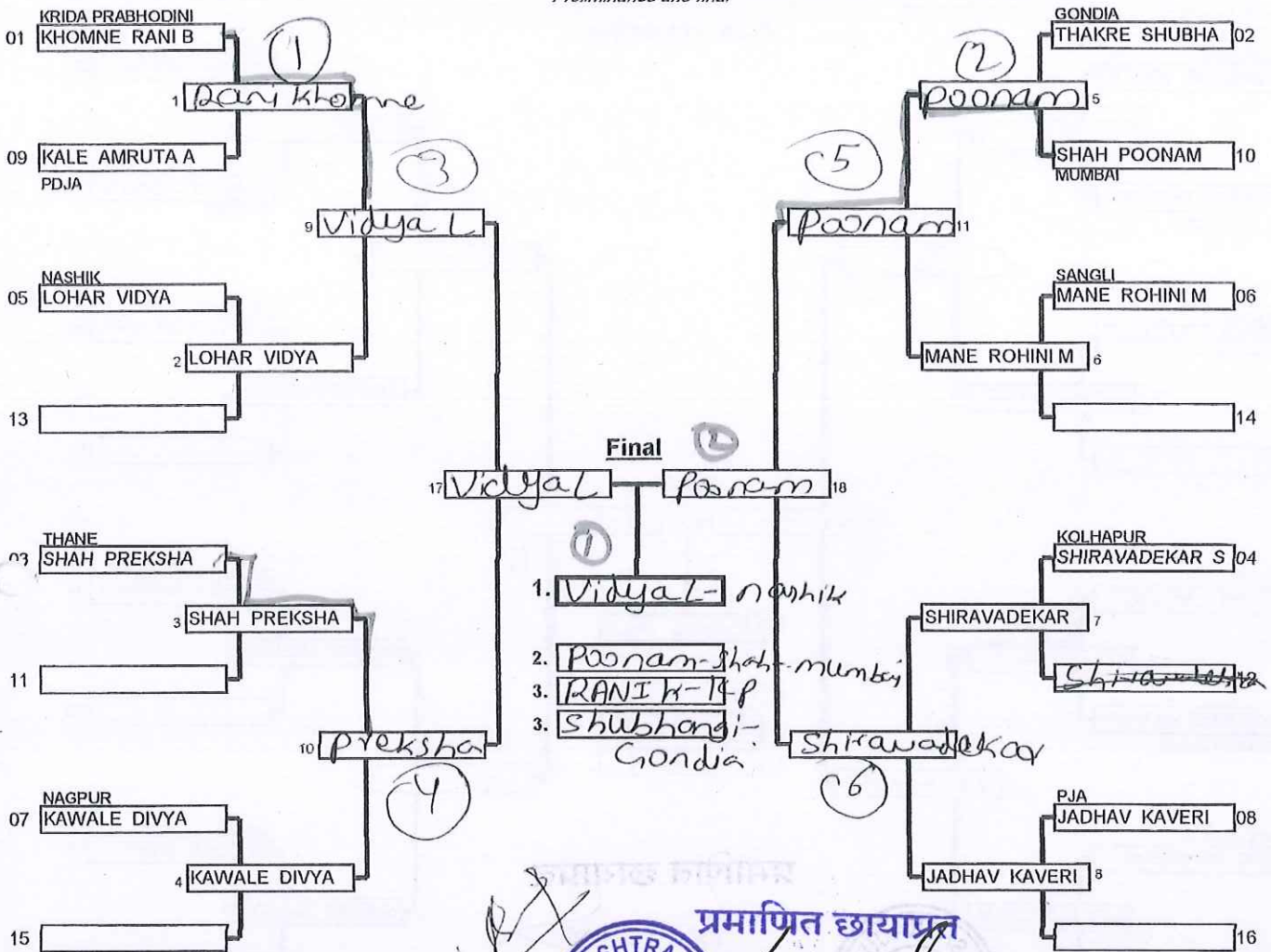

प्रमाणित छायाप्रत

दत्ता आफळे
जानरल सेक्रेटरी
महाराष्ट्र ज्युडो असोसिएशन

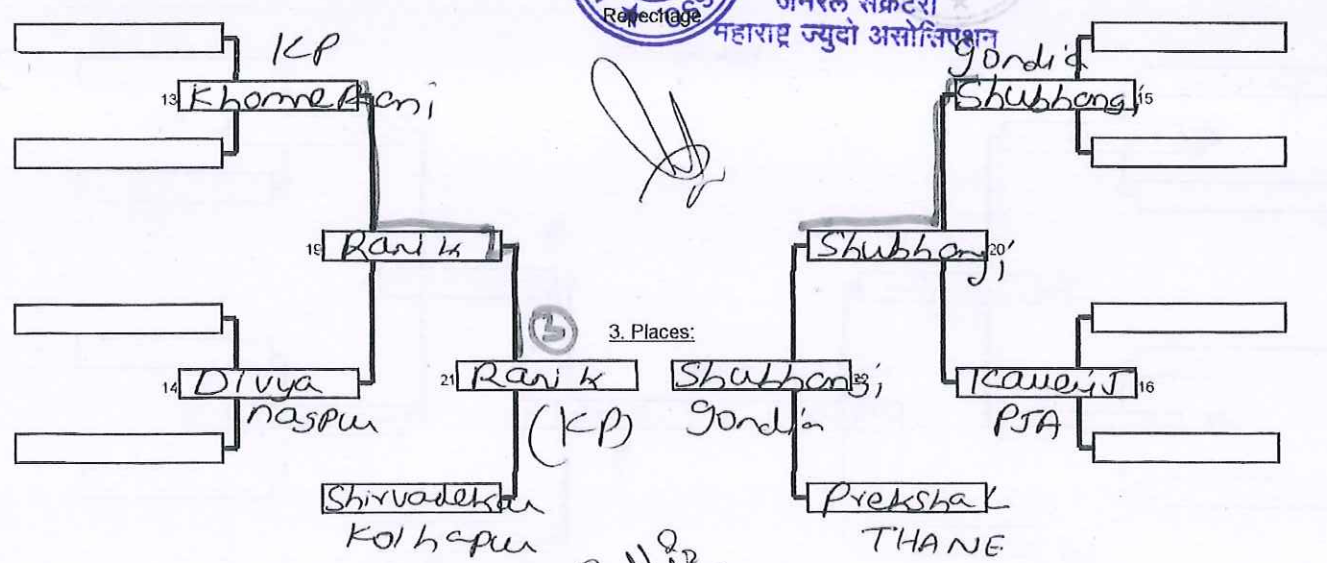

Shubhangi

SENIOR WOMEN	- 44 KG	46th SENIOR STATE ME & NATIONAL TRIAL CHA	DHULE MAHARASHT	22-23/12/2011	11	Cmp.
Elimination System with Double Repechage for 9 to 16 Competitors				4 min	Matte	

Preliminaries and final

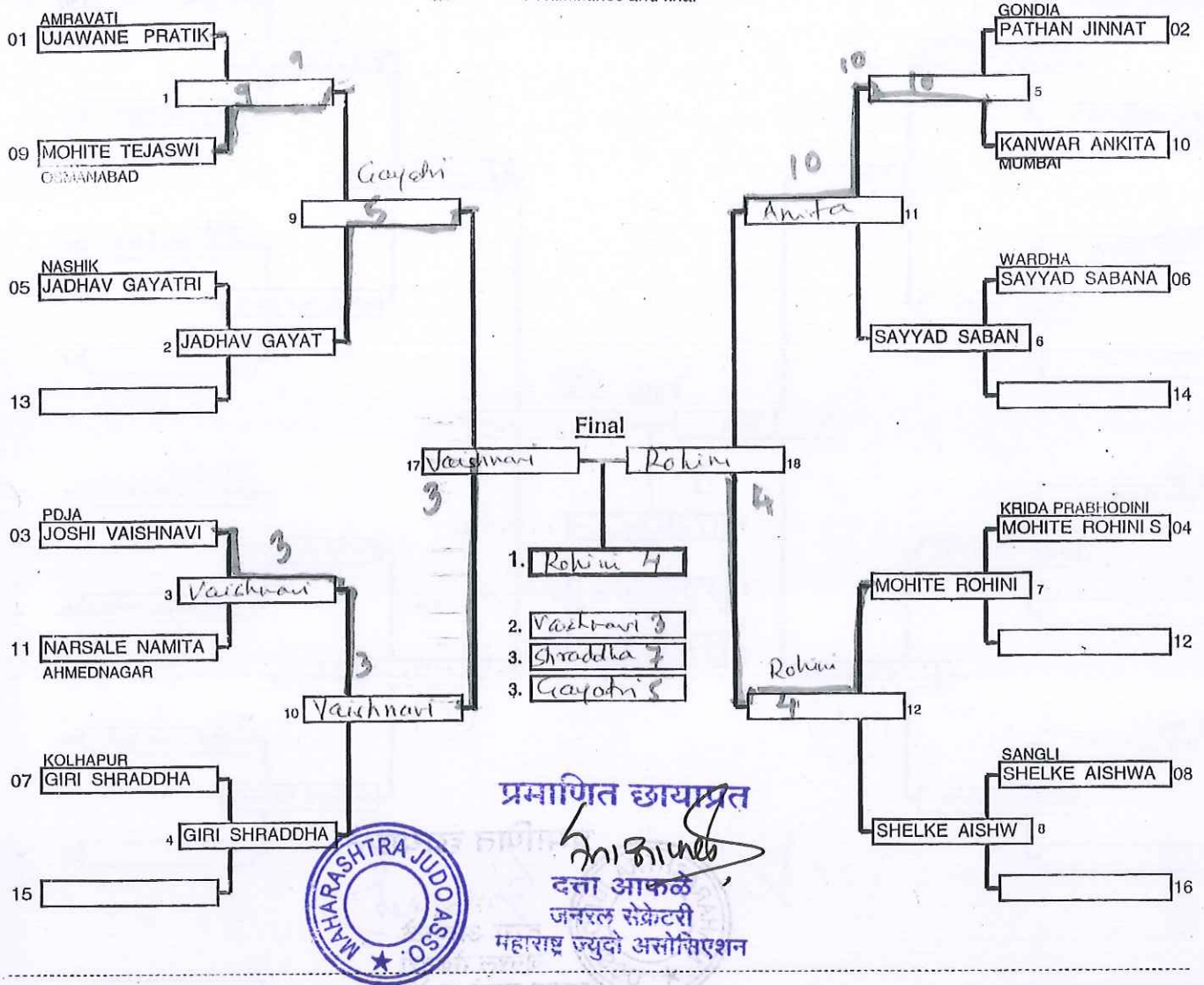

Repechage

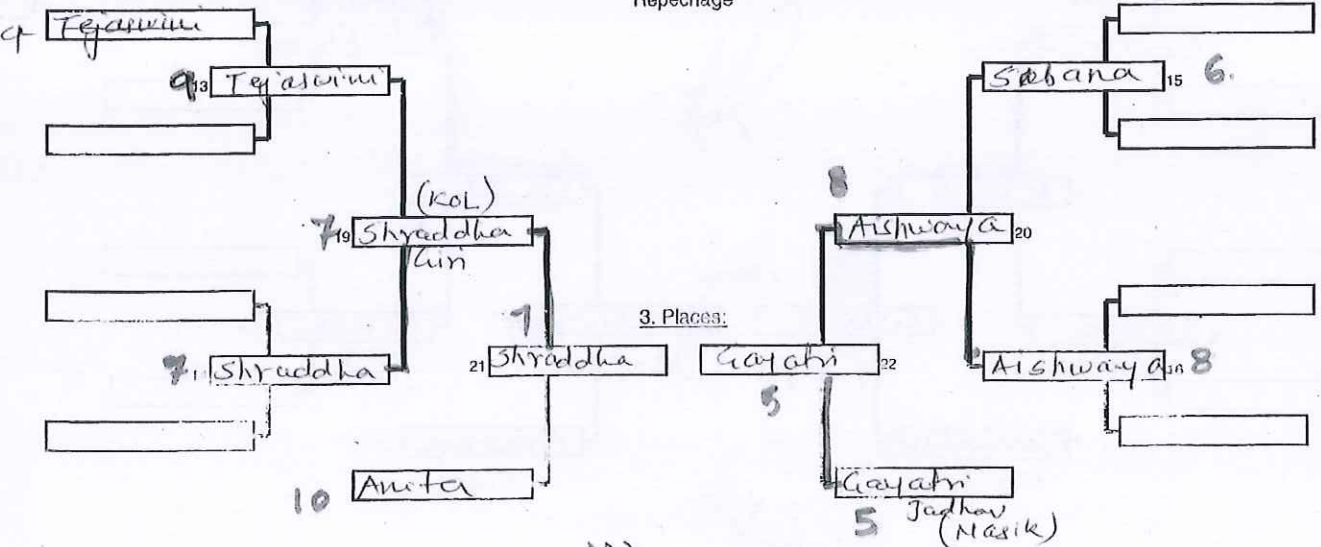

(Handwritten signatures and names)

46th SENIOR STATE MEN & WOMEN JU Venue **DHULE MAHARASHTRA** Date: **22-23/12/2018**
& NATIONAL TRIAL CHAMPIONSHIP 20 Organized by: **MAHARASHTRA JUDO ASSOCIATION**

Winner list *

List only ranks <= 3 Place

SENIOR MEN	- 56 KG	(16)	1	UGHADE	ASHISH	AURANGABAD	India
			2	CHAUDHARI	MAYUR	DHULE	India
			3	DEVKAR	ANIKET	PDJA	India
				PATIL	AVADHOOT	KOLHAPUR	India
SENIOR MEN	- 60 KG	(18)	1	KHAWALE	MANISH	PDJA	India
			2	BHOSALE	RANVIRSIN	KOLHAPUR	India
			3	SHEDGE	SHRAVAN	AURANGABAD	India
				PATIL	SACHIN	SINDHUDURG	India
SENIOR MEN	- 66 KG	(18)	1	MATE	AJINKAY	AURANGABAD	India
			2	ANIKET	GUPTA	MUMBAI	India
			3	VAIDYA	AJINKYA	NASHIK	India
				KALE	SAIPRASAD	NAGPUR	India
SENIOR MEN	- 73 KG	(16)	1	ADSUL	RAM	PJA	India
			2	SONAWANE	ANKIT	AURANGABAD	India
			3	GAIKWAD	PRADIP	KRIDA PRABHODINI	India
				SAYYAD	FIROJ	AHMEDNAGAR	India
SENIOR MEN	- 81 KG	(13)	1	THITE	HARSHAL	AURANGABAD	India
			2	SUTAR	SOURAV	KOLHAPUR	India
			3	BHOSALE	RUSHIRAJ	SATARA	India
				SHAIKH	FAYAZ	MUMBAI	India
SENIOR MEN	- 90 KG	(14)	1	SALUNKE	SADASHIV	PDJA	India
			2	LANDGE	GANESH	AHMEDNAGAR	India
			3	YADAV	PRADEEP	MUMBAI	India
				MANDHARE	SWAPNIL	THANE	India
SENIOR MEN	- 100 KG	(10)	1	DESAI	VIKAS	PDJA	India
			2	POTALE	SHREYAS	NASHIK	India
			3	KALE	PRASHANT	PJA	India
				GAHERWAR	AMOL	DHULE	India
SENIOR MEN	+ 100 KG	(13)	1	INGVALE	VIKRANT	KOLHAPUR	India
			2	KADAM	ROHIT	PJA	India
			3	PATIL	KISHORE	SANGLI	India
				SHAIKH	MUZAMMIL	AURANGABAD	India

प्रमाणित छाप

दत्ता आफळे
जनरल सेक्रेटरी



महाराष्ट्र ज्युदो असोसिएशन

JUDO Turnier Manager, Version 6.01 ; This Freeware copy to be used by 'JUDO FEDERATION OF INDIA'

46th SENIOR STATE MEN & WOMEN JU Venue DHULE MAHARASHTRA Date: 22-23/12/2018
& NATIONAL TRIAL CHAMPIONSHIP 20 Organized by: MAHARASHTRA JUDO ASSOCIATION

Winner list *

List only ranks <= 3 Place

SENIOR WOMEN - 44 KG	(11)	1	MOHITE	ROHINI S	KRIDA PRABHODINI	India
		2	JOSHI	VAISHNAVI	PDJA	India
		3	GIRI	SHRADDHA	KOLHAPUR	India
			JADHAV	GAYATRI	NASHIK	India
SENIOR WOMEN - 48 KG	(10)	1	LOHAR	VIDYA	NASHIK	India
		2	SHAH	POONAM	MUMBAI	India
		3	KHOMNE	RANI B	KRIDA PRABHODINI	India
			THAKRE	SHUBHANGI	GONDIA	India
SENIOR WOMEN - 52 KG	(11)	1	KHAVARE	SNEHAL R	KRIDA PRABHODINI	India
		2	SANAS	PRIYANKA	MUMBAI	India
		3	SANGLE	RASIKA T	PDJA	India
			MAGDUM	SONALI	KOLHAPUR	India
SENIOR WOMEN - 57 KG	(9)	1	RAUT	SHUBHANG	NAGPUR	India
		2	GHERADE	MADHURI B	AURANGABAD	India
		3	PANDE	SAPANA S	KRIDA PRABHODINI	India
			VEJLANI	SARAH	THANE	India
SENIOR WOMEN - 63 KG	(8)	1	DONGRE	RUTUJA R	PDJA	India
		2	KALE	ASHWINI	AHMEDNAGAR	India
		3	MALIYE	HEMA	AMRAVATI	India
			AUTADE	KAJAL R	KRIDA PRABHODINI	India
SENIOR WOMEN - 70 KG	(6)	1	DHOPESHWAR	RUCHA R	PDJA	India
		2	TAMBOLI	TANVIN R	KRIDA PRABHODINI	India
		3	VASEKAR	PRATIKSHA	MUMBAI	India
			MATRE	SHILPA	AHMEDNAGAR	India
SENIOR WOMEN - 78 KG	(4)	1	SHIRSAT	SUREKHA	AHMEDNAGAR	India
		2	PHATERPEKAR	POOJA	MUMBAI	India
		3	BAKODE	SAPANA R	AMRAVATI	India
SENIOR WOMEN + 78 KG	(4)	1	PATIL	APOORVA	THANE	India
		2	PAWAR	PRATIKSHA	SATARA	India
		3	SHETTY	MAYURI	MUMBAI	India

प्रमाणित छायाप्रत

(Signature)
 दत्ता आफळे
 जनरल सेक्रेटरी
 महाराष्ट्र ज्युदो असोसिएशन



JUDO Turnier Manager, Version 6.01 ; This Freeware copy to be used by 'JUDO FEDERATION OF INDIA'